

COMP *A-I-R*[™] basic

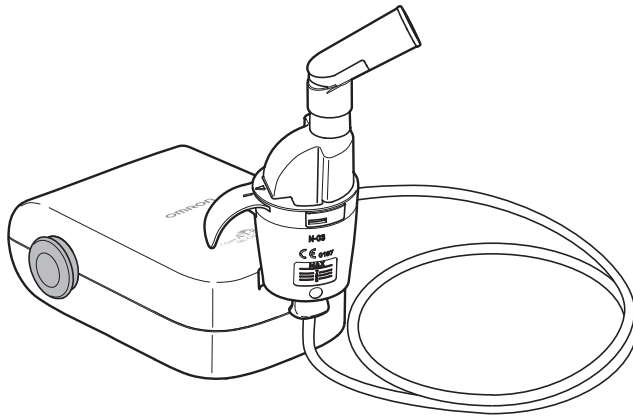

Compressor Nebulizer **NE-C803 (NE-C803-E)** Instruction Manual

IM-NE-C803-E-06-04/2022
8300641-7F

Issue Date / Date de publication / Ausgabedatum /
Data di pubblicazione / Fecha de publicación / : 2022-05-18
Datum van uitgifte / Дата выпуска / رادصل إلى خيرات

All for Healthcare

EN

FR

DE

IT

ES

NL

RU

AR

Contents

Before using the device

Introduction.....	2
Intended use.....	3
Important safety instructions.....	4
Know your unit.....	7
Optional Medical Accessories.....	8
Other Optional/Replacement Parts.....	8

Operating instructions

How to use.....	9
-----------------	---

Care and maintenance

Cleaning and disinfecting.....	13
Removing condensation from the air tube.....	15
Changing the air filter.....	15
Troubleshooting.....	16
Technical data.....	17
Guarantee.....	22

Introduction

Thank you for purchasing the OMRON COMP AIR basic.

This product was developed in conjunction with respiratory therapists for the successful treatment of asthma, chronic bronchitis, allergies and other respiratory disorders.

This is a medical device. Operate the device only as instructed by your doctor and/or respiratory therapist.

How the nebulizer kit works

The medication that is pumped up through the medication channel is mixed with compressed air which is generated by a compressor pump.

The medication is turned into fine particles and sprayed when in contact with the compressed air.

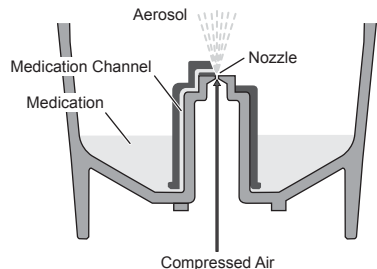

Intended use

Medical Purpose

This product is intended to be used for inhaling medication for respiratory disorders. The compressor and its AC adapter are intended to be multiple patient multiple use. The nebulizer kit and its attachments are single patient multiple use.

Intended User

- Legally certified medical experts, such as doctor, nurse and therapist.
- Caregiver or patient under the guidance of qualified medical experts for home treatment.
- The user should also be capable of understanding general operation of NE-C803 and the content of this instruction manual.

Intended Patients

This product should not be used on patients, who are unconscious or are not breathing spontaneously.

Environment

This product is intended for use in a medical facility, such as Hospital, clinic and doctor's office, and in a room of general household.

Durable period

Durable periods are as follows, provided the product is used to nebulize 2 ml of medication twice a day for 7.5 minutes each time at room temperature (23°C).

Durable period may vary depending on usage environment.

Frequent use of the product may shorten the durable period.

Compressor (Main unit)	5 years
Nebulizer Kit	1 year
Mouthpiece	1 year
Nosepiece	1 year
Air Tube (PVC, 100cm)	1 year
Air Filter	60 days
Mask (PVC) (SEBS)	1 year

Precautions for use

Warnings and cautions described in the instruction manual should be observed.

Important safety instructions

Read all the information in the instruction manual and any other literature included in the box before using the device.

 **Warning:** Indicates a potentially hazardous situation which, if not avoided, could result in serious injury.

(Usage)

- For type, dose, and regime of medication follow the instructions of your doctor or respiratory therapist.
- If you experience any allergic reactions or other difficulties during use, stop using the device immediately and consult your doctor.
- Do not use only water in the nebulizer for inhaling purposes.
- Keep the device out of reach of unsupervised infants and children. The device may contain small pieces that can be swallowed.
- Do not store the air tube while there is moisture or medication remaining inside.
- Do not use or store the device where it may be exposed to noxious fumes or volatile substances.
- Do not use the device where it may be exposed to flammable gas.
- Do not cover the compressor with a blanket, towel, or any other type of cover during use.
- Always dispose of any remaining medication after use, and use fresh medication each time.
- Do not use in anaesthetic or ventilator breathing circuits.
- Store the parts in a clean location to avoid infection.

(Risk of electrical shock)

- Never plug or unplug the AC adapter with wet hands.
- The compressor and the AC adapter are not waterproof. Do not spill water or other liquids on these parts. If liquid does spill on these parts, immediately unplug the AC adapter and wipe off the liquid with gauze or other absorbent material.
- Do not immerse the compressor in water or other liquid.
- Do not use or store the device in humid locations.
- Do not operate the device with a damaged power cord or plug.
- Keep the power cord away from heated surfaces.
- Use only original OMRON AC adapter. Use of unsupported AC adapter may damage the device.

(Cleaning and disinfecting)

Observe the rules below when cleaning or disinfecting parts. Failure to observe these rules may result in damage, inefficient nebulization or infection. For the instructions, refer to “Cleaning and disinfecting” section.

- Clean and disinfect the nebulizer kit, mask, mouthpiece or nosepiece before using them when as follows:
 - the first time after purchase.
 - if the device has not been used for a long period of time
 - if more than one person uses the same device
- Be sure to wash or wipe the parts after use, and ensure that they are thoroughly disinfected and dried, and stored in a clean location.
- Do not leave the cleaning solution to dry on parts.

⚠ Caution: Indicates a potentially hazardous situation which if not avoided, may result in minor or moderate injury, or physical damage.

(Usage)

- In order to prevent strangulation by the power cord or air tube, or injuries caused by mishandling, please provide close supervision when this device is used by, on, or near children or invalids.
- Make sure that the parts are attached correctly.
- Make sure that the air filter is correctly attached.
- Make sure that the air filter is clean. If the air filter has been used for more than 60 days, replace it with a new one.
- Do not tilt the nebulizer kit at an angle of greater than 45 degrees in all directions or shake it while in use.
- Do not use or store the device while the air tube is creased.
- Use only original nebulizing parts, air tube, air filter and air filter cover.
- Do not add more than 10 ml of medication to the medication tank.
- Do not carry or leave the nebulizer kit while the medication tank contains medication.
- Do not leave the device unattended with infants or persons who cannot express their consent.
- Do not subject the device to any strong shocks such as dropping on the floor.
- Do not jab the nozzle of the medication tank with a pin or any sharp object.
- Do not insert fingers or objects inside the compressor.
- Do not disassemble or attempt to repair the compressor or AC adapter.
- Do not leave the device in extreme hot or cold temperature, or under direct sunlight.
- Do not use the device while sleeping or if drowsy.
- Approved for human use only.
- The compressor may become hot during operation.
- Do not touch the compressor for other than necessary operation such as turning off the power while nebulizing.
- To avoid the medication residue on the face, be sure to wipe the face after removing the mask.
- To avoid injury to the nose mucosa, do not squeeze the nosepiece into the back of the nose.
- Do not use a damaged nebulizer kit, mouthpiece or nosepiece.
- While using this device, make sure that no mobile phone or any other electrical devices that emit electromagnetic fields is within 30cm. This may result in degradation of performance of the device.
- The nebulizer kit and its attachments are intended for use by a single patient. Do not use by multiple patients; Use separate accessories for each patient.

(Risk of electrical shock)

- Always unplug the AC adapter from the power outlet after use and before cleaning.
- Plug the device into the appropriate voltage outlet. Do not overload power outlets or use extension cords.
- Do not misuse the power cord of AC adapter.
- Do not wind the power cord around the compressor or AC adapter.
- Do not pull the power cord of AC adapter strongly.
- Changes or modifications not approved by OMRON HEALTHCARE will void the user warranty.
- Always remove the AC adapter from the device after use and before cleaning.

(Cleaning and disinfecting)

Observe the rules below when cleaning or disinfecting parts. Failure to observe these rules may result in damage, inefficient nebulization or infection. For the instructions, refer to “Cleaning and disinfecting” section.

- Do not use a microwave oven, dish dryer or hair dryer to dry the device or the parts.
- Do not use an autoclave, EOG gas sterilizer or low temperature plasma sterilizer.
- When disinfecting parts by boiling, make sure that the container does not boil dry. Otherwise it may also result in a fire.

General Safety Precautions:

- Inspect the device before using them each time, and check that there are no problems. In particular, be sure to check the following:
 - That the vaporizer head, nozzle or air tube are not damaged.
 - That the nozzle is not blocked.
 - That the compressor operates normally.
- When using this device, there will be some noise and vibration caused by the pump in the compressor. There will also be some noise caused by the emission of compressed air from the nebulizer kit. This is normal and does not indicate a malfunction.
- Operate the device only as intended. Do not use the device for any other purpose.
- Do not use the device at temperatures greater than +40°C.
- Make sure that the air tube is securely attached to the compressor and nebulizer kit, and does not come loose.
- To completely isolate the device from the power source unplug the plug from the power source.

Keep these instructions for future reference.

Know your unit

Compressor (Main Unit)* x 1

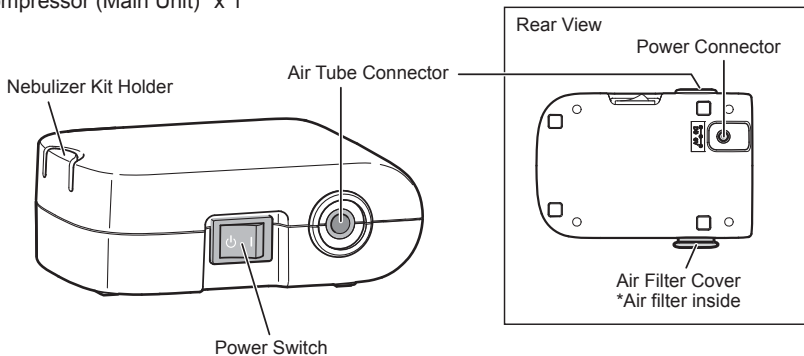

Nebulizer Kit* x 1

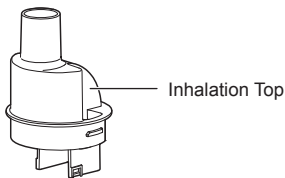

Vaporizer Head

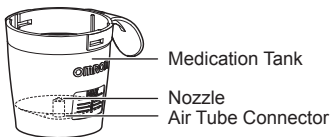

Air Tube*
(PVC, 100cm) x 1



Mouthpiece* x 1



Nosepiece* x 1



Adult Mask (PVC)* x 1



Child Mask (PVC)* x 1



Spare Air Filters x 5

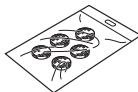

AC Adapter x 1
Storage Bag x 1
Instruction Manual

* These parts comply with EN ISO 27427:2019

EN

Optional Medical Accessories

Product description	Model
Nebulizer Kit & Mouthpiece Set*	NEB-NSET3-83E
Adult Mask (PVC)*	NEB-MSLP-E
Child Mask (PVC)*	NEB-MSMP-E
Adult Mask (SEBS)*	NEB-MSLS-E
Child Mask (SEBS) Set*	NEB-MSSS-E
Mouthpiece*	NEB-MP-E
Nosepiece*	NEB-NP-E
Air Tube (PVC, 100cm)*	NEB-TP-82E
AC Adapter	HHP-CM01

* These parts comply with EN ISO 27427:2019

Other Optional/Replacement Parts

Product description	Model
Air Filters x 5	NEB-AFR-30E

How to use

⚠ Warning:

Clean and disinfect the nebulizer kit, mask, mouthpiece or nosepiece before using them when as follows:

- the first time after purchase.
- if the device has not been used for a long period of time
- if more than one person uses the same device

For the instructions, refer to “Cleaning and disinfecting” section.

1. Make sure that the power switch is in the off () position.

2. Connect the AC adapter to the compressor and plug the power plug into a power outlet.

Note:

Do not place the device in a location where it is difficult to disconnect the power cord.

3. Remove the inhalation top together with vaporizer head from the medication tank.

Note:

If the vaporizer head came off the inhalation top and fell into the medication tank, remove it out of the tank.

4. Add the correct amount of prescribed medication to the medication tank.

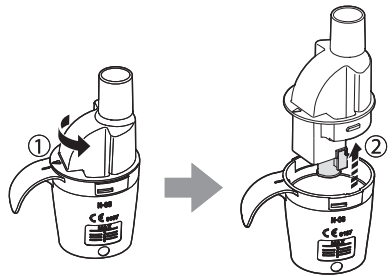

5. Make sure that the vaporizer head is securely attached to the inhalation top.

Note:

The sizes of the left- and right-hand attached parts of the vaporizer head are not the same. If the vaporizer head is not attached in the correct orientation, it will not nebulize correctly.

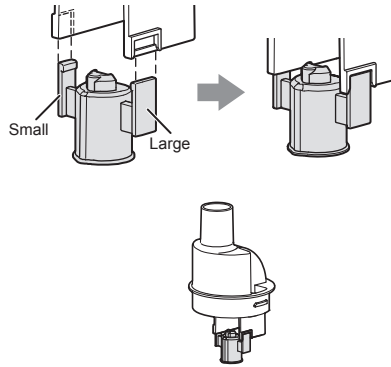

6. Put the inhalation top back inside the medication tank.
- 1) Align the protrusion on the inhalation top with the indent on the medication tank, as shown.

- 2) Rotate the inhalation top clockwise until the arrow mark on it and the alignment mark on the medication tank are aligned, and they click in place.

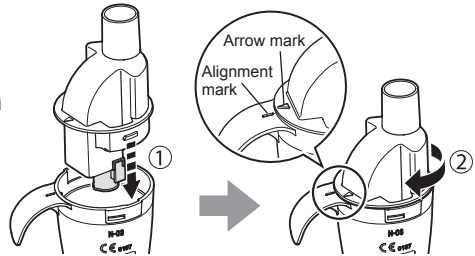

7. Attach the mask, mouthpiece or nosepiece to the nebulizer kit tightly.

Note:

Make sure that these attachments are fitted in such a way that the handle is positioned away from the patient. Otherwise, medication may be sprayed on patient's skin or clothes.

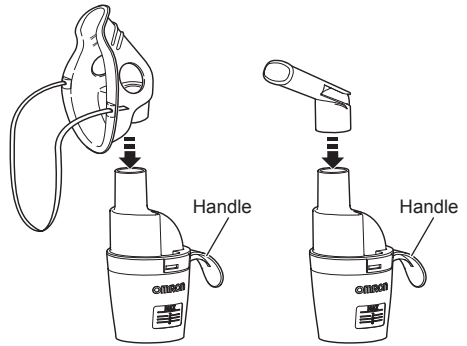

8. Attach the air tube.
Push the air tube plugs firmly into the air tube connectors.

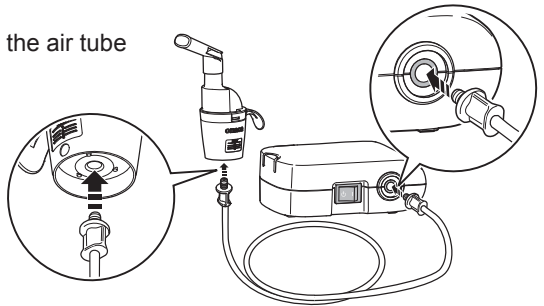

The nebulizer kit can be fixed on the compressor.

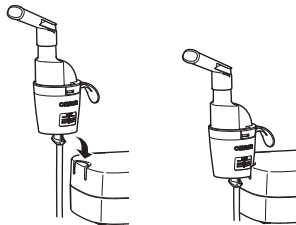

9. Hold the nebulizer kit as indicated on the right. Follow the instructions of your doctor or respiratory therapist. Exhale as normal through mouthpiece, mask or through the nose.

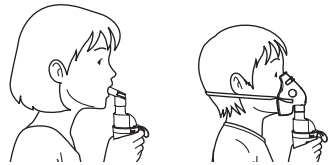

⚠ Caution:

Do not tilt the nebulizer kit at an angle of greater than 45 degrees in all directions. Medication may flow into the mouth or it may result in not nebulizing effectively.

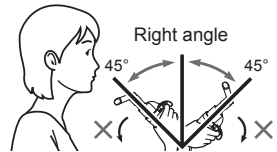

10. Press the power switch to the on (**I**) position. As the compressor starts, nebulization begins and aerosol is generated. Inhale the medication.
11. When treatment is complete, turn the power off. Unplug the AC adapter from the power outlet and disconnect it from the compressor.

Note:

Securely hold and press the power plug down to disconnect the AC adapter.

⚠ Caution:

Do not pull the power cord. Damage may be caused.

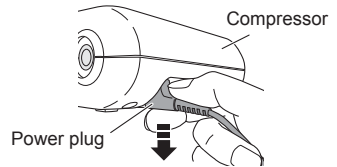

Cleaning and disinfecting

Caution: Handling the Vaporizer Head

- Always wash the vaporizer head after each use.
- Do not use a brush or pin to clean the vaporizer head.
- When disinfecting the parts by boiling, be sure to boil them in plenty of water.
- Do not boil vaporizer head together with objects other than applicable nebulizer accessories.

Cleaning

Clean the parts after each use to remove residual medication. This will avoid inefficient nebulization or infection.

■ Washable parts

• **Nebulizer Kit (Inhalation top, Medication tank), Mask (PVC)/(SEBS), Mouthpiece, Nosepiece**

Wash them in warm water and mild detergent (neutral detergent). Rinse them thoroughly with clean hot tap water and allow to air dry in a clean place.

• **Vaporizer Head**

Wash it with running water.

■ Non-washable parts

• **Compressor, Air Tube**

Firstly, make sure that the power plug is unplugged from the power outlet. Wipe clean with a soft cloth moistened with water or mild detergent (neutral detergent).

• **Air Filter**

Do not wash or clean the air filter. If the air filter becomes wet, replace it. Damp air filters can cause blockages.

Disinfecting

Always disinfect the parts after the last treatment of the day. If the parts are heavily stained, replace them with new ones. It is expected to withstand 365 cycles of disinfection during its one-year durable period.

To select a method for disinfection, refer to the table on page 14.

O: applicable X: not applicable

Disinfecting method	Parts	Mouthpiece	Nosepiece	Nebulizer Kit	Adult Mask (SEBS) (optional) Child Mask (SEBS) (optional)	Adult Mask (PVC) Child Mask (PVC)	Air Tube (PVC, 100cm)	Air Filter
	Materials	PP	PP	PP (Vaporizer Head: PC)	Mask: SEBS Band: Rubber*** Adapter: PP	Mask: PVC (Phthalate free) Band: Rubber***	PVC (Phthalate free)	Polyester
A	Alcohol	O	O	O	O**	O**	X	X
	Disinfecting ethanol							
	Sodium hypochlorite	O	O	O	O**	O**	X	X
Milton* (0.1%, 15min.)								
B	Boiling	O	O	O	O**	X	X	X

A. Use a commercially available disinfectant. Follow the instructions provided by the disinfectant manufacturer.

Note: Never clean with benzene or thinner.

B. Parts may be boiled between 15 to 20 minutes.
After boiling, carefully remove the parts, shake off excess water and allow to air dry in a clean environment.

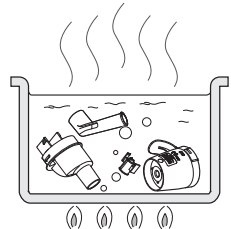

* an example of commercially available disinfectant. (The concentration and residence time specified in the table are under the conditions where the service life of the parts is tested with each disinfectant used as described in its instruction manual. Please note that the testing was not performed for the purpose of ensuring the effectiveness of the disinfectants. There is no intention of suggesting that such disinfectants be used. Conditions of use and ingredients of disinfectant vary for manufacturers. Please read the instruction manuals carefully before use and apply disinfectant to each part in an appropriate way. Please notice that service life of the parts may be shorter depending on conditions, environments and frequency of use.)

** Remove the rubber band from mask before disinfecting.

*** The band is not made with natural rubber latex.

Removing condensation from the air tube

If there is moisture or liquid remaining in the air tube, be sure to follow the procedure below to remove any moisture from within the air tube.

- 1) Make sure that the air tube is connected to the air connector on the compressor.
- 2) Remove the air tube from the nebulizer kit.
- 3) Turn on the compressor and pump air through the air tube to expel the moisture.

Changing the air filter

If the air filter has been used for more than 60 days, replace it with a new one.

1. Pull the air filter cover off the compressor.

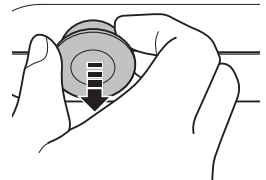

2. Change the air filter.

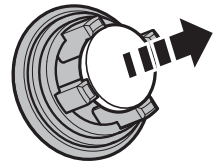

3. Put the air filter cover back in place.
Make sure it is attached properly.

Notes:

- Use only OMRON air filters designed for this device. Do not operate without air filter.
- Do not wash or clean the air filter. If the air filter becomes wet, replace it. Damp air filters can cause blockages.
- There is no front or back orientation for the air filters.
- Check that air filters are clean and free of dust before inserting them.

Troubleshooting

In case of any of the below problems occur during use, first check that no other electrical device is within 30cm. If the problem persists, please refer to the table below.

Problem	Cause	Remedy
Nothing happens when the power switch is pressed.	Is the AC adapter connected correctly to a power outlet and the compressor?	Check that the AC adapter is connected to a power outlet and the compressor. Unplug then reinsert the plug if necessary.
No nebulization or low nebulization rate, when the power is on.	Is there medication in the medication tank?	Add the correct amount of medication to the medication tank.
	Is there too much/little medication in the medication tank?	
	Is the vaporizer head missing or not assembled correctly?	Attach the vaporizer head correctly.
	Is the nebulizer kit assembled correctly?	Assemble the nebulizer kit correctly.
	Is the nozzle blocked?	Make sure that the nozzle is free of blockages.
	Is the nebulizer kit tilted at a sharp angle?	Make sure that the nebulizer kit is not tilted at an angle of more than 45 degrees.
	Is the air tube connected correctly?	Make sure that the air tube is correctly connected to the compressor and nebulizer kit.
	Is the air tube folded?	Make sure that the air tube is not twisted or bended.
	Is the air tube blocked?	Make sure that the air tube is free of blockages.
	Is the air filter dirty?	Replace the air filter with a new one.
The compressor is abnormally loud.	Is the air filter cover attached correctly?	Attach the air filter cover correctly.
The compressor is very hot.	Is the compressor being covered?	Do not cover the compressor during operation.

Note: If the suggested remedy does not solve the problem, do not try to repair the device - the device are not user serviceable. Return the device to an authorized OMRON retail outlet or distributor.

Technical data

Product Category:	Nebulizers
Product Description:	Compressor Nebulizer
Model (code):	NE-C803 (NE-C803-E)
Rating (AC adapter):	100 - 240V \sim 50-60Hz 0.12 - 0.065A
Rating (Compressor Nebulizer):	6V = 0.7A
Operating Temperature/Humidity/ Air Pressure:	+10°C to +40°C / 30% to 85%RH (non-condensing) / 700 to 1060hPa
Storage and Transport Temperature/ Humidity/Air Pressure:	-20°C to +60°C / 10% to 95%RH (non-condensing) / 700 to 1060hPa
Weight:	Approx. 180g (compressor only)
Dimensions:	Approx. 85 (W) × 43 (H) × 115 (D) mm (compressor only)
Contents:	Compressor, Nebulizer Kit, Air Tube (PVC, 100cm), Mouthpiece, Nosepiece, Adult Mask (PVC), Child Mask (PVC), 5 pcs Spare Air Filters, AC Adapter, Storage Bag, Instruction Manual.
Classifications:	Class II (Protection against electric shock), Type BF (Applied part); Mouthpiece, Mask, Nosepiece IP21 (Ingress Protection)















CE 0197











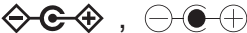
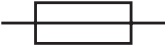

Notes:

- Subject to technical modification without prior notice.
- This OMRON product is produced under the strict quality system of OMRON HEALTHCARE Co., Ltd., Japan.
- The device may not work if the temperature and voltage conditions are different to those defined in the specifications.
- If the device is stored at the maximum or minimum storage and transport temperature and is moved to an environment with a temperature of 20°C, we recommend waiting for approx. 30 minutes before using the device.
- The device fulfils the provisions of the European Standard EN13544-1:2007+A1:2009, Respiratory therapy equipment - Part1: Nebulizing systems and their components and EN ISO 27427:2019 Anaesthetic and respiratory equipment - Nebulizing systems and components.
- IP classification is degrees of protection provided by enclosures in accordance with IEC 60529. The compressor and the AC adapter are protected against solid foreign objects of 12.5 mm diameter and greater such as a finger, and against vertically falling water drops which may cause issues during a normal operation.

- See website of OMRON HEALTHCARE EUROPE to update technical information.
URL: www.omron-healthcare.com
- This device can be used for continuous operation.
- Please report to the manufacturer and the competent authority of the Member State in which you are established about any serious incident that has occurred in relation to this device.

Symbols description	
	Need for the user to follow this instruction manual thoroughly for your safety.
	Need for the user to consult the instructions for use
	Applied part - Type BF Degree of protection against electric shock (leakage current)
	Class II Protection against electric shock
IP XX	Ingress protection degree provided by IEC 60529
	CE Marking
	Unique device identifier
	Serial number
	LOT number
	Medical device
	Date of manufacture
	Temperature limitation
	Humidity limitation
	Atmospheric pressure limitation
	Power OFF or Stand-by

	Power ON
	Indication of connector polarity
	Fuse
	For indoor use only
	Alternating current
	Direct current
	Certified by TÜV
	Efficiency Level of power supply
	The company logo of AC adapter supplier
	The company logo of AC adapter supplier
	Trademark of OMRON compressor nebulizers (COMP A-I-R, COMP A-I-R basic, COMP A-I-R Elite, COMP A-I-R Pro)
	Trademark of OMRON mesh nebulizers
	Trademark of OMRON ultrasonic nebulizers

Technical data for the OMRON NE-C803 Compressor with the Nebulizer kit:

Type of Medication Liquid:	Solution, Suspension
Particle Size:	** MMAD Approx. $3\mu\text{m}$ (2.5%NaF)
Medication Tank Capacity:	10ml maximum
Appropriate Medication Quantities:	2ml minimum - 10ml maximum
Residual Volume:	Approx. 0.7ml
Sound:	* Noise level (at 1 m distance) 45 dB
Nebulization Rate:	* Approx. 0.30ml/min (by weight loss)
Aerosol Output:	** 0.37ml (2ml, 1%NaF)
Aerosol Output Rate:	** 0.05ml/min (2ml, 1%NaF)
Percentage of Fill Volume Emitted Per Minute:	2.5%

Result of cascade impactor measurements for particle size**

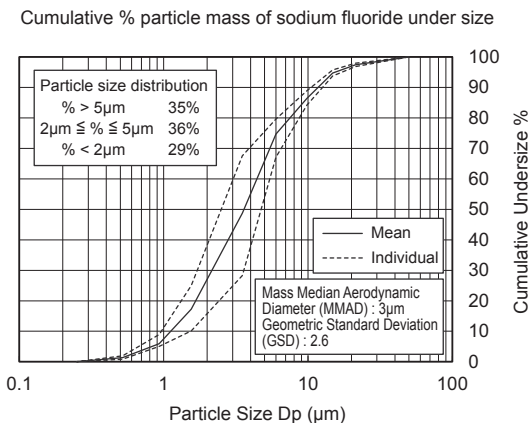

* Measured by OMRON HEALTHCARE Co., Ltd. Measured with saline at ambient temperature of 23°C and humidity of 40%. It may vary with the type of medication.

** Independently measured by Prof. Dr. Hiroshi Takano, Therapeutic Systems Research Center, Doshisha University, Kyoto, Japan, according to EN 13544-1:2007+A1:2009.

Notes:

- Performance may vary with medication such as suspensions or high viscosity. See medication supplier's data sheet for further details.
- The particle size distribution and aerosol output may vary by combination of product, medication and ambient conditions such as temperature, humidity and atmospheric pressure.
- The disclosures for nebulizer performance are based upon testing that utilizes adult ventilatory patterns and are likely to be different from those stated for paediatric or infant populations.

Important information regarding Electromagnetic Compatibility (EMC)

NE-C803-E manufactured by OMRON HEALTHCARE Co., Ltd. conforms to EN60601-1-2:2015 Electromagnetic Compatibility (EMC) standard.

Further documentation in accordance with this EMC standard is available at OMRON HEALTHCARE EUROPE at the address mentioned in this instruction manual or at www.omron-healthcare.com. Refer to the EMC information for NE-C803-E on the website.

***Correct Disposal of This Product
(Waste Electrical & Electronic Equipment)*****EN**

This marking shown on the product or its literature, indicates that it should not be disposed of, with other household wastes at the end of its working life. To prevent possible harm to the environment or human health from uncontrolled waste disposal, please separate this product from other types of wastes and recycle it responsibly to promote the sustainable reuse of material resources.

Household users should contact either the retailer where they purchased this product, or their local government office, for details of where and how they can return this item for environmentally safe recycling.

Business users should contact their supplier and check the terms and conditions of the purchase contract. This product should not be mixed with other commercial waste for disposal.

Guarantee

Thank you for buying an OMRON product. This product is constructed of high quality materials and great care has been taken in its manufacturing. It is designed to give you a high level of comfort, provided that it is properly operated and maintained as described in the instruction manual.

This product is guaranteed by OMRON for a period of 3 years after the date of purchase. The proper construction, workmanship and materials of this product is guaranteed by OMRON. During this period of guarantee OMRON will, without charge for labour or parts, repair or replace the defect product or any defective parts.

The guarantee covers only products purchased in Europe, Russia and other CIS countries, Middle East and Africa.

The guarantee does not cover any of the following:

- a. Transport costs and risks of transport.
- b. Costs for repairs and / or defects resulting from repairs done by unauthorised persons.
- c. Periodic check-ups and maintenance.
- d. Failure or wear of accessories or other attachments other than the main device itself, unless explicitly guaranteed above.
- e. Costs arising due to non-acceptance of a claim (those will be charged for).
- f. Damages of any kind including personal caused accidentally or from misuse.

Should guarantee service be required please apply to the dealer whom the product was purchased from or an authorised OMRON distributor. For the address refer to the product packaging / literature or to your specialised retailer. If you have difficulties in finding OMRON customer services, visit our website (www.omron-healthcare.com) for contact information.

Repair or replacement under the guarantee does not give rise to any extension or renewal of the guarantee period.

The guarantee will be granted only if the complete product is returned together with the original invoice / cashticket issued to the consumer by the retailer. OMRON reserves the right to refuse the guarantee service if any unclear information has been given.

Manufacturer 	OMRON HEALTHCARE Co., Ltd. 53, Kunotsubo, Terado-cho, Muko, KYOTO, 617-0002 JAPAN		
EU-representative <table border="1" data-bbox="98 214 230 256"> <tr> <td data-bbox="98 214 163 256">EC</td> <td data-bbox="165 214 230 256">REP</td> </tr> </table>	EC	REP	OMRON HEALTHCARE EUROPE B.V. Scorpius 33, 2132 LR Hoofddorp, THE NETHERLANDS www.omron-healthcare.com
EC	REP		
Importer in EU			
Production facility	OMRON HEALTHCARE MANUFACTURING VIETNAM CO., LTD. No.28 VSIP II, Street 2, Vietnam-Singapore Industrial Park II, Binh Duong Industry-Services-Urban Complex, Hoa Phu Ward, Thu Dau Mot City, Binh Duong Province, Vietnam		
Subsidiaries	OMRON HEALTHCARE UK LTD. Opal Drive, Fox Milne, Milton Keynes, MK15 0DG, UK www.omron-healthcare.com/distributors		
	OMRON MEDIZINTECHNIK HANDELSGESELLSCHAFT mbH www.omron-healthcare.com/distributors		
	OMRON SANTÉ FRANCE SAS www.omron-healthcare.com/distributors		

Made in Vietnam