

OMRON

EN

FR

DE

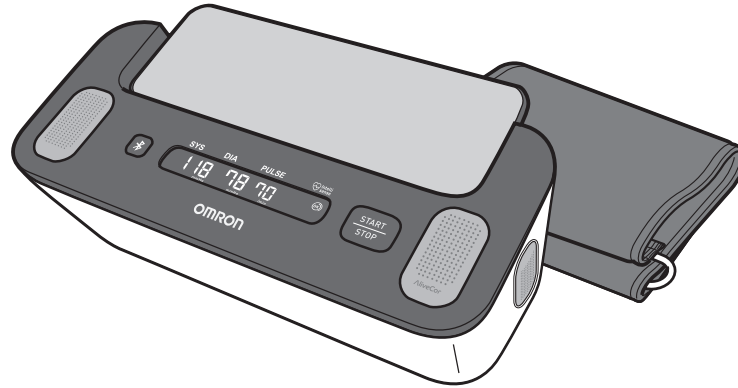

**Automatic Upper Arm Blood Pressure Monitor + ECG
Complete (HEM-7530T-E3)
Instruction Manual ①**

All for Healthcare

CE 0197

UK
CA
0086

 **Intelli[®]
sense**

Table of Contents

Introduction	EN2
Safety Instructions	EN2
Intended Use	EN3
Receiving and Inspection	EN3
Important Safety Information	EN4
1. Know Your Monitor	EN10
1.1 Contents	EN10
1.2 Monitor and Arm Cuff	EN10
1.3 BP Reading Display and Symbols on the Monitor	EN11
1.4 2018 ESH/ESC** Guidelines for the management of arterial hypertension	EN13
1.5 Reading Your ECG Result	EN14
1.6 Distinction between Pulse Rate and Heart Rate	EN18
2. Preparation	EN19
2.1 Installing Batteries	EN19
2.2 Pairing Your Monitor with a Smartphone	EN21
2.3 Blood Pressure Measurement/ ECG Recording Tips	EN23
3. Taking a Blood Pressure Measurement and Recording an ECG	EN24
3.1 Applying the Arm Cuff	EN24
3.2 Sitting Correctly	EN26
3.3 Taking a Blood Pressure Measurement and Recording an ECG	EN27
4. Taking Only a Blood Pressure Measurement	EN33
5. Recording Only an ECG	EN36
6. Transferring Your Blood Pressure Readings Manually	EN39
7. Taking a Blood Pressure Measurement Manually	EN40
8. Other Settings of the Monitor	EN41
8.1 Disabling/Enabling Bluetooth	EN41
8.2 Restoring Your Monitor to the Default Settings	EN42
9. Tracking Your Memory in the App	EN43
9.1 Tracking Your ECG Recordings	EN43
9.2 Tracking Your Blood Pressure Readings	EN43
10. ECG Settings and Adjustments in the App	EN44
10.1 Recording Review Adjustments	EN44
10.2 Adjustable Settings	EN44
11. Error Messages and Troubleshooting	EN45
12. Maintenance	EN51
12.1 Maintenance	EN51
12.2 Storage	EN51
12.3 Cleaning	EN53
12.4 Calibration and Service	EN53
13. Optional Accessories	EN54
14. Specifications	EN55
15. Limited Warranty	EN58
16. Guidance and Manufacturer's Declaration	EN59

Introduction

Thank you for purchasing the OMRON Complete Automatic Upper Arm Blood Pressure Monitor + ECG. This monitor has 2 main features; a blood pressure measurement and an electrocardiogram (ECG or EKG) recording. There are 3 ways to use this monitor: measuring blood pressure only; ECG only; blood pressure and ECG simultaneously. Visit the “Help” section in the “OMRON connect” app for additional information about using the app.

Blood pressure measurement

This monitor uses the oscillometric method of blood pressure measurement. This means this monitor detects your blood movement through your brachial artery and converts the movement into a digital reading.

Electrocardiogram (ECG or EKG) recording

This model also has a clinical-quality ECG recorder which allows users to record and display ECGs on their smartphones with the “OMRON connect” app.

The “OMRON connect” app also provides analysis results of the recorded ECG to evaluate whether the heart rhythm is normal or if possible atrial fibrillation, bradycardia and tachycardia are detected.

ECG software and technology powered by AliveCor is embedded on the OMRON connect app and is an integral part of the OMRON Complete blood pressure monitor + ECG system.

Safety Instructions

This instruction manual provides you with important information about the OMRON Complete Automatic Upper Arm Blood Pressure Monitor + ECG. To ensure the safe and proper use of this monitor, READ and UNDERSTAND all of these instructions. **If you do not understand these instructions or have any questions, contact your OMRON retail outlet or distributor before attempting to use this monitor. For specific information about your own blood pressure and heart related conditions, consult with your physician.**

Intended Use

The device is intended to measure blood pressure only, electrocardiogram (ECG) only or blood pressure and ECG simultaneously.

The device is a digital monitor intended for use in measuring blood pressure and pulse rate in adult population.

The device is intended to record, store, and transfer single-channel electrocardiogram (ECG) rhythms. The device in combination with a smartphone, displays ECG rhythms and detects the presence of atrial fibrillation, bradycardia, tachycardia and normal sinus rhythm. The device is intended for use by healthcare professionals, patients with known or suspected heart conditions, and health-conscious individuals in a general household situation. The device has not been tested and it is not intended for pediatric use.

Receiving and Inspection

Remove this monitor and other components from the packaging and inspect for damage. If this monitor or any other components are damaged, DO NOT USE and contact your OMRON retail outlet or distributor.

Important Safety Information

Read the Important Safety Information in this instruction manual before using this monitor.

Follow this instruction manual thoroughly for your safety.

Keep for future reference. For specific information about your own blood pressure and heart related conditions, **CONSULT WITH YOUR PHYSICIAN.**



Warning

Indicates a potentially hazardous situation which, if not avoided, could result in death or serious injury.

- DO NOT use this monitor on infants, toddlers, children or persons who cannot express themselves.
- DO NOT adjust medication based on readings from this blood pressure monitor and/or ECG recordings. Take medication as prescribed by your physician. ONLY a physician is qualified to diagnose and treat high blood pressure and other heart related conditions.
- DO NOT use this monitor on an injured arm/fingers or an arm/fingers under medical treatment.
- DO NOT apply the arm cuff on your arm while on an intravenous drip or blood transfusion.
- DO NOT use this monitor in areas containing high frequency (HF) surgical equipment, magnetic resonance imaging (MRI) equipment, computerized tomography (CT) scanners. This may result in incorrect operation of the monitor and/or cause an inaccurate blood pressure readings and/or ECG recordings.
- DO NOT use this monitor in oxygen rich environments or near flammable gas.
- Consult with your physician before using this monitor if you have common arrhythmias such as atrial or ventricular premature beats or atrial fibrillation; arterial sclerosis; poor perfusion; diabetes; pregnancy; pre-eclampsia or renal disease. NOTE that any of these conditions in addition to patient motion, trembling, or shivering may affect the blood pressure readings and/or ECG recordings.
- NEVER diagnose or treat yourself based on your blood pressure readings and/or ECG recordings. ALWAYS consult with your physician.
- To help avoid strangulation, keep the air tube away from infants, toddlers and children.

- Keep components out of the reach of infants, toddlers and children.
This product contains small parts that may cause a choking hazard if swallowed by infants, toddlers and children.
- DO NOT record an ECG with a cardiac pacemaker, Implantable Cardioverter Defibrillators, or other implanted electronic devices.

Data Transmission

- This product emits radio frequencies (RF) in the 2.4 GHz band. DO NOT use this product in locations where RF is restricted, such as on an aircraft or in hospitals.
Turn off the **Bluetooth**[®] feature in this monitor, remove batteries when in RF restricted areas.

Battery Handling and Usage

- Keep batteries out of the reach of infants, toddlers and children.

Caution

Indicates a potentially hazardous situation which, if not avoided, may result in minor or moderate injury to the user or patient, or cause damage to the equipment or other property.

- Stop using this monitor and consult with your physician if you experience skin irritation or discomfort.
- Consult with your physician before using this monitor on an arm where intravascular access or therapy, or an arterio-venous (A-V) shunt, is present because of temporary interference to blood flow which could result in injury.
- Consult with your physician before using this monitor if you have had a mastectomy.
- Consult with your physician before using this monitor if you have severe blood flow problems or blood disorders as cuff inflation can cause bruising.
- DO NOT take blood pressure measurements more often than necessary because bruising, due to blood flow interference, may occur.
- ONLY inflate the arm cuff when it is applied on your upper arm.
- Remove the arm cuff if it does not start deflating during a blood pressure measurement.

Important Safety Information

- When the monitor malfunctions, it may get hot. DO NOT touch the monitor if it occurs.
- DO NOT use this monitor for any purpose other than measuring blood pressure and/or recording an ECG.
- During a blood pressure measurement and/or an ECG recording, make sure that no mobile device or any other electrical device that emits electromagnetic fields, other than the smartphone to be used with the monitor, is within 30 cm of this monitor. This may result in incorrect operation of the monitor and/or cause inaccurate blood pressure readings and/or ECG recordings.
- DO NOT disassemble or attempt to repair this monitor or other components. This may cause inaccurate blood pressure readings and/or ECG recordings.
- DO NOT use in a location where there is moisture or a risk of water splashing this monitor. This may damage this monitor.
- DO NOT use this monitor in a moving vehicle such as in a car, on an air craft or during physical activity.
- DO NOT drop or subject this monitor to strong shocks or vibrations.
- DO NOT use or store this monitor in places with high or low humidity, high or low temperatures or in bright and sunny environments. Refer to section 14.
- Ensure this monitor is not impairing blood circulation by observing the arm while blood pressure measurement is occurring.
- DO NOT use this monitor in high-use environments such as medical clinics or physician offices.
- DO NOT use this monitor with other medical electrical (ME) equipment simultaneously. This may result in incorrect operation of the devices and/or cause an inaccurate blood pressure readings and/or ECG recordings.
- Avoid bathing, drinking alcohol or caffeine, smoking, exercising and eating for at least 30 minutes before taking a blood pressure measurement.
- Rest for at least 5 minutes before taking a blood pressure measurement.
- Remove tight-fitting and thick clothing from your arm while taking a blood pressure measurement.
- Remain still and DO NOT talk while taking a blood pressure measurement.
- Remain still while recording an ECG.
- ONLY use the arm cuff on persons whose arm circumference is within the specified range of the cuff.

- Ensure that this monitor has acclimated to room temperature before taking a blood pressure measurement and/or recording an ECG. Taking a blood pressure measurement and/or recording an ECG after an extreme temperature change could lead to an inaccurate blood pressure readings and/or ECG recordings. OMRON recommends waiting for approximately 2 hours for the monitor to warm up or cool down when the monitor is used in an environment within the temperature specified as operating conditions after it is stored either at the maximum or at the minimum storage temperature. For additional information of operating and storage/transport temperature, refer to section 14.
- DO NOT use this monitor after the durable period has ended. Refer to section 14.
- DO NOT crease the arm cuff or the air tube excessively.
- DO NOT fold or kink the air tube while taking a blood pressure measurement. This may cause an injury by interrupting blood flow.
- To unplug the air plug, pull on the plastic air plug at the base of the tube, not the tube itself.
- ONLY use the approved arm cuff for this monitor. Use of other arm cuffs may result in incorrect blood pressure readings.
- Inflating to a higher pressure than necessary may result in bruising of the arm where the cuff is applied.
NOTE: please refer to section 7 for taking a blood pressure measurement manually.
- ONLY use the arm cuff, batteries and accessories specified for this monitor. Use of unsupported arm cuffs and batteries may damage and/or may be hazardous to this monitor.
- The use of accessories and cables other than those specified or provided by OMRON could result in increased electromagnetic emission or decreased electromagnetic immunity of the monitor and result in improper operation.
- During a blood pressure measurement and/or an ECG recording, the use of the monitor adjacent to or stacked with another device, other than the smartphone to be used with the monitor, should be avoided because it could result in improper operation. In case such use is necessary, the monitor and the other device should be observed to verify that they are operating normally.
- OMRON makes no warranty for any data or information that is collected erroneously by the monitor, or misuse or malfunction as a result of abuse, accidents, alteration, misuse, neglect, or failure to maintain the product as instructed.

Important Safety Information

- Interpretations made by this monitor are potential findings, not a complete diagnosis of cardiac conditions. All interpretations should be reviewed by a medical professional for clinical decision-making.
- DO NOT use this monitor in the presence of flammable anesthetics or drugs.
- DO NOT expose this monitor to strong electromagnetic fields.
- DO NOT use this monitor while charging your smartphone.
- DO NOT record an ECG in close vicinity to other equipment emitting acoustic sound.
- DO NOT record an ECG if the electrodes are dirty. Clean them first.
- After ECG analysis, the app may incorrectly identify ventricular flutter, ventricular bigeminy, and ventricular trigeminy heart conditions as unreadable. Consult with your physician.
- OMRON does not guarantee that you are not experiencing an arrhythmia or other health conditions when labeling an ECG as normal. You should notify your physician for possible changes in your health.
- If the “OMRON connect” app detects possible atrial fibrillation in an ECG, consult with your physician before making any medical decision, including altering your use of any drug or treatment.
- The atrial fibrillation detector evaluates for possible atrial fibrillation ONLY. It will NOT detect other potentially life threatening arrhythmias, and it is possible that other cardiac arrhythmias may be present.
- The atrial fibrillation detector ONLY evaluates for possible atrial fibrillation after you have recorded an ECG. It does NOT continuously monitor your heart and therefore cannot alert you if atrial fibrillation happens at any other time.
- Result of “Bradycardia” or “Tachycardia” are designations of heart rate, not a clinical diagnosis of an actual arrhythmia. Consult with your physician.
- When your fingertips are dry, your ECG recording may not be successful. If dry, moisten your fingers with a wet towel, a water-based lotion, or something similar.
- DO NOT record an ECG with dirty hands.
- Make sure to place your smartphone on the smartphone stand of the monitor when recording an ECG. If it is not placed appropriately on the smartphone stand, there may be communication issues between the smartphone and the monitor, and your ECG may not be recorded successfully.

- The ECG electrodes should not touch any other conductive parts.
- If you wear hearing aids, turn them off while recording an ECG.

Data Transmission

- DO NOT replace batteries while your blood pressure readings are being transferred to your smartphone. This may result in incorrect operation of this monitor and failure to transfer your blood pressure readings.

EN

Battery Handling and Usage

- DO NOT insert batteries with their polarities incorrectly aligned.
- ONLY use 4 “AA” alkaline batteries with this monitor. DO NOT use other types of batteries. DO NOT use new and used batteries together. DO NOT use different brands of batteries together.
- Remove batteries if this monitor will not be used for 3 months or more.
- If battery fluid should get in your eyes, immediately rinse with plenty of clean water. Consult with your physician immediately.
- If battery fluid should get on your skin, wash your skin immediately with plenty of clean, lukewarm water. If irritation, injury or pain persists, consult with your physician.
- DO NOT use batteries after their expiration date.
- Periodically check batteries to ensure they are in good working condition.
- Make sure the battery compartment is securely closed with the battery cover when recording an ECG. If the battery cover is not in place, recording an ECG may not be successful. If you have lost the battery cover, contact your OMRON retail outlet or distributor.

1. Know Your Monitor

1.1 Contents

Monitor, arm cuff (HEM-RML31), storage case, 4 “AA” alkaline batteries, instruction manual, setup instructions, blood pressure diary

1.2 Monitor and Arm Cuff



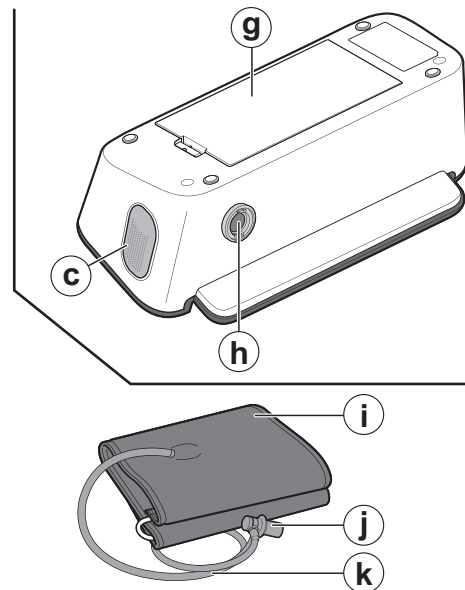
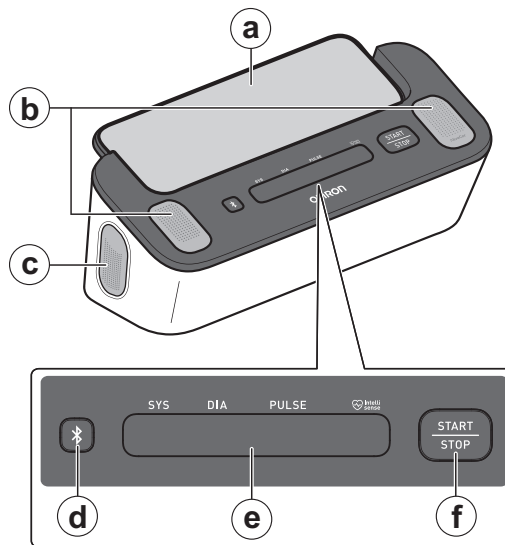

- (a) Smartphone stand
- (b) Top electrodes
- (c) Side electrode (both sides)
- (d) [Connection] button
- (e) BP reading display*
- (f) BP [START/STOP] button*
- (g) Battery compartment
- (h) Air jack
- (i) Arm cuff
(Arm circumference 22 - 42 cm)
- (j) Air plug
- (k) Air tube

*BP indicates blood pressure.

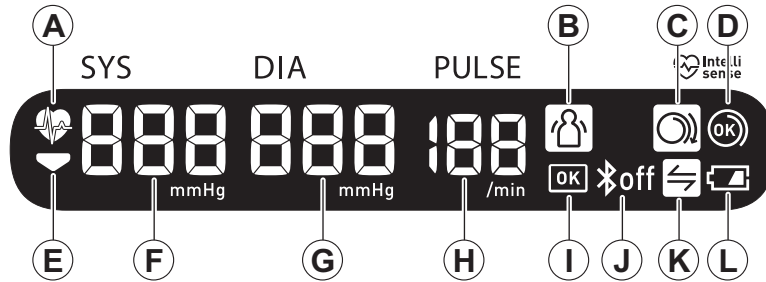







1.3 BP Reading Display and Symbols on the Monitor



A		Heartbeat symbol Flashes while taking a blood pressure measurement.
B		Movement error symbol Appears along with a blood pressure reading when your body is moving during a blood pressure measurement. If it appears, remove the arm cuff, and wait for 2 to 3 minutes. Then, remain still and take another measurement.
C		Cuff wrap guide symbol (loose) Appears if the arm cuff is not wrapped around the arm correctly while taking a BP measurement.
D		Cuff wrap guide symbol (OK) Appears if the arm cuff is wrapped around the arm correctly while taking a BP measurement.
E		Deflation symbol Appears during cuff deflation.

1. Know Your Monitor

Ⓕ		Systolic blood pressure reading
Ⓖ		Diastolic blood pressure reading
Ⓗ		Pulse display Pulse rate appears after the blood pressure measurement.
Ⓘ		OK symbol Flashes when your monitor is connected to your smartphone or readings are transferred successfully.
Ⓙ		Bluetooth ON symbol Appears when your blood pressure readings are being transferred.
		Bluetooth OFF symbol Appears when Bluetooth is disabled.
Ⓚ		Sync symbol Flashes/appears when your data needs to be transferred because the internal stored blood pressure memory is either almost, or completely full. Once you pair your monitor with your smartphone, transfer your blood pressure readings immediately before the monitor deletes the oldest blood pressure readings. Up to 90 blood pressure readings can be stored in the internal memory of your monitor.
Ⓛ		Low battery symbol Appears when batteries are low.
		Depleted battery symbol Appears when batteries are depleted.

1.4 2018 ESH/ESC** Guidelines for the management of arterial hypertension

Definitions of hypertension by office and home blood pressure levels

	Office	Home
Systolic Blood Pressure	≥ 140 mmHg	≥ 135 mmHg
Diastolic Blood Pressure	≥ 90 mmHg	≥ 85 mmHg

These ranges are from statistical values for blood pressure.

** European Society of Hypertension (ESH) and European Society of Cardiology (ESC).

Warning

- NEVER diagnose or treat yourself based on your blood pressure readings and/or ECG recordings. ALWAYS consult with your physician.

1. Know Your Monitor

1.5 Reading Your ECG Result

When the ECG recording is finished, the results are displayed on the downloaded “OMRON connect” app as: Possible Afib (possible atrial fibrillation), Bradycardia, Tachycardia, Normal, Unreadable or Unclassified.

Note

- Other than Possible Afib, Bradycardia, Tachycardia, Normal, Unclassified and Unreadable, ECG error messages may appear on the app due to some reasons such as a shortage of recording time, too noisy to interpret or etc. If it appears, follow the suggestions on the app.
- You must download and follow up instructions for setting up the app.

Atrial Fibrillation detector

The Atrial Fibrillation detector detects possible atrial fibrillation in an ECG tracing. After you record an ECG, if possible atrial fibrillation is detected you will be notified as Possible Afib, within the app. This finding is not a diagnosis, it is only a potential finding for the recorded ECG. You should contact your physician to review any ECG recording in which possible atrial fibrillation was detected. If you are experiencing any symptoms or concerns contact a medical professional.

Atrial fibrillation means the most common type of non-sinus tachyarrhythmia. In atrial fibrillation, disorganized electrical impulses that originate in the atria and pulmonary veins initiate the electrical activity in the conduction system of the heart. This causes what are commonly termed as “irregularly irregular” heart beats.

When a heart is in atrial fibrillation, its two upper chambers, the right and left atria, essentially quiver instead of beating efficiently.

This does not allow for complete emptying of the atria and thus blood may become stagnant and create blood clots.

This can lead to major health problems, including strokes, transient ischemic attacks (TIAs), and pulmonary emboli (PEs); depending which chamber of the heart has the blood clot in it.

Approximately 15 percent of strokes occur in people with atrial fibrillation. As age increases in a population, so too does the incidence of atrial fibrillation, which peaks at about 3-5 % in people over the age of 65.

The most common presenting symptoms of atrial fibrillation are palpitations, dizziness, fast heart rate, irregularly irregular rhythm, an abnormal heart sound (S1), chest pain, chronic shortness of breath, abnormal jugular venous pressure, fatigue, and impaired exercise tolerance. Other symptoms related to TIAs and strokes may be the initial symptoms of atrial fibrillation. Some of the most common causes of atrial fibrillation are long-standing hypertension, congestive heart disease, cardiac valvular lesions, myocardial infarctions, history of coronary artery bypass grafts, hyperthyroidism, alcohol abuse, smoking, diabetes mellitus, and electrolyte imbalances.

Bradycardia detector

Bradycardia detector detects bradycardia, in an ECG tracing.

After you record an ECG, if bradycardia is detected you will be notified as Bradycardia within the app.

Bradycardia means a type of arrhythmia due to slower heart rate (40-50 beats per minute). The app analyzes ECGs to detect normal sinus rhythm without major abnormalities between 40-50 beats per minute.

Tachycardia detector

Tachycardia detector detects tachycardia, in an ECG tracing.

After you record an ECG, if tachycardia is detected you will be notified as Tachycardia within the app.

Tachycardia means a type of arrhythmia due to faster heart rate (100-140 beats per minute). The app detects normal sinus rhythm without major abnormalities at these heart rates.

Normal detector

Normal detector notifies you as Normal within the app, when a ECG recording is normal.

1. Know Your Monitor

Normal means that the heart rate is between 50 and 100 beats per minute, there are no or very few abnormal beats, and the shape, timing and duration of each beat is considered normal sinus rhythm. It is important to remember that there is a wide range of normal variability among different individuals. Changes in the shape or timing of an ECG might be normal for a single individual, but since the apps are used by a large and diverse population, the Normal detector has been designed to be conservative with what it detects as normal.

If you have been diagnosed with a condition that affects the shape of your ECG (e.g., intraventricular conduction delay, left or right bundle branch block, Wolff-Parkinson-White Syndrome, etc.), experience a large number of premature ventricular or atrial contractions (PVC and PAC), are experiencing an arrhythmia, or took a poor-quality recording it is unlikely that you will be notified that your ECG is normal.

It is also important to note that the Normal detector looks at the entire signal before determining if it can be declared to be normal. If you experience a small number of PACs or PVCs in a recording of otherwise normal beats in normal rhythm, the Normal detector will likely declare that ECG recording to be normal.

The Normal detector will not declare an ECG outside the heart rate of 50-100 beats per minute as normal, even if the ECG has normal sinus rhythm. As a result, if you typically get normal results but take an ECG immediately after any physical activity that raises your heart rate above 100 beats per minute, you may not get a normal result.

Unreadable detector

The Unreadable detector determines whether a recording can be accurately interpreted or not. After recording an ECG, if interference is detected you will be notified within the app that your recording has “No analysis” and given some suggestions for acquiring good quality ECG recording. You subsequently have the option to save the recording, or try again. If the recording can be analyzed, the Atrial Fibrillation, Bradycardia, Tachycardia and Normal detectors will run on the ECG and inform you as described previous pages.

Unclassified

The app may display the Unclassified message for an ECG recording that was not detected as normal, nor as possible atrial fibrillation, nor as bradycardia, nor as tachycardia, and not as unreadable.

Unclassified means the result is not Normal, nor Possible Afib, nor Bradycardia, nor Tachycardia and not Unreadable. Unclassified result may be normal rhythms, such as when your heart rate is higher than 100 beats per minute after physical activity, or abnormal rhythms; if you consistently get unclassified results, you may want to share your these ECG recordings with your physician. You can send the recordings by email.

Caution

- After ECG analysis, the app may incorrectly identify ventricular flutter, ventricular bigeminy, and ventricular trigeminy heart conditions as unreadable. Consult with your physician.
 - OMRON does not guarantee that you are not experiencing an arrhythmia or other health conditions when labeling an ECG as normal. You should notify your physician for possible changes in your health.
 - If the “OMRON connect” app detects possible atrial fibrillation in an ECG, consult with your physician before making any medical decision, including altering your use of any drug or treatment.
 - The atrial fibrillation detector evaluates for possible atrial fibrillation ONLY. It will NOT detect other potentially life threatening arrhythmias, and it is possible that other cardiac arrhythmias may be present.
 - The atrial fibrillation detector ONLY evaluates for possible atrial fibrillation after you have recorded an ECG. It does NOT continuously monitor your heart and therefore cannot alert you if atrial fibrillation happens at any other time.
 - Result of “Bradycardia” or “Tachycardia” are designations of heart rate, not a clinical diagnosis of an actual arrhythmia. Consult with your physician.
-

1. Know Your Monitor

1.6 Distinction between Pulse Rate and Heart Rate

The pulse rate on blood pressure measurement and the heart rate on ECG recording are calculated differently as follows. There may be a difference between both values.

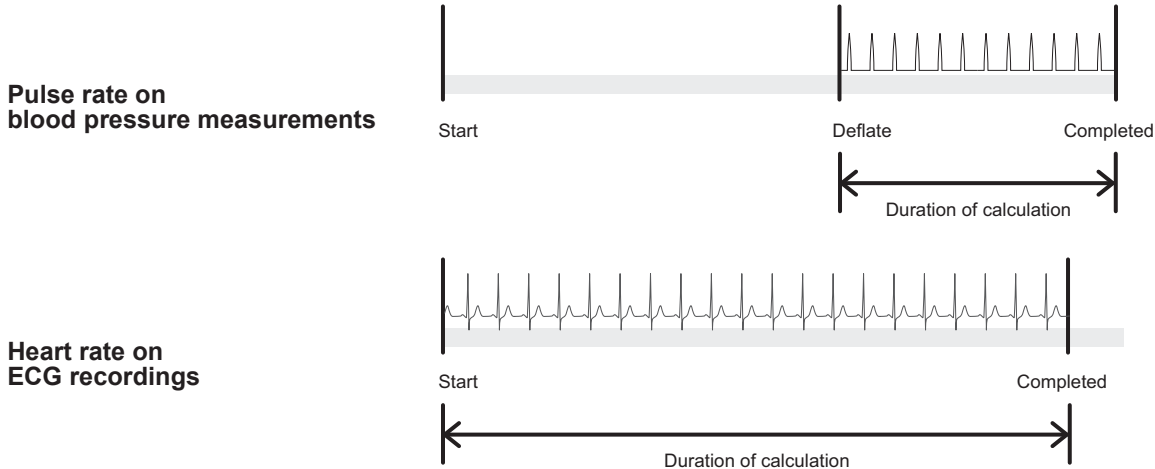

2. Preparation

2.1 Installing Batteries

1. Insert a thin object such as the tip of a pen or a thin screwdriver, in the hole of the battery cover hook. Push the hook horizontally, then pull it upward as shown in the image.

Note

- When using a thin object, be careful not to get yourself injured.

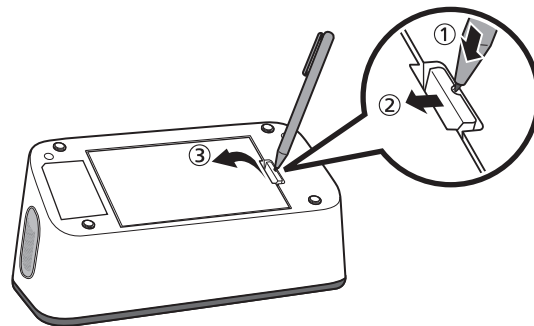

EN

2. Insert 4 “AA” alkaline batteries as indicated in the battery compartment.

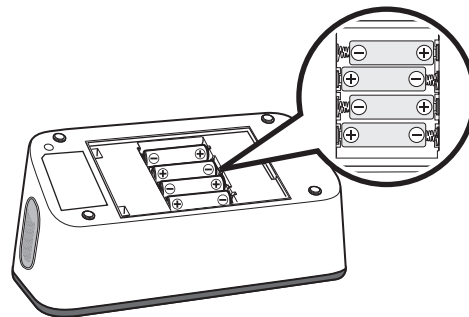

EN19

2. Preparation

3. Close the battery cover securely.

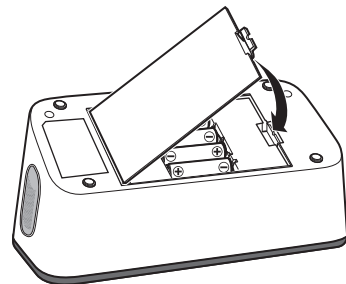

Note

- When the “” symbol appears on the BP reading display, it is recommended you replace batteries.
- To replace batteries, turn your monitor off and remove all batteries. Then replace with 4 new alkaline batteries at the same time.
- Before taking blood pressure measurements, your monitor needs to be set with the correct date and time. The date and time are automatically set when you pair with and/or transfer your blood pressure readings to your smartphone. However, the date and time will only be set for future blood pressure measurements taken after the blood pressure reading that was transferred, it will not be saved as the blood pressure reading that was just transferred. For pairing or transferring instructions, refer to sub-section 2.2.
- Replacing batteries will not delete previous blood pressure readings.
- The supplied batteries may have a shorter life span than new batteries.
- Disposal of used batteries should be carried out in accordance with local regulations.

Caution

- Make sure the battery compartment is securely closed with the battery cover when recording an ECG. If the battery cover is not in place, recording an ECG may not be successful. If you have lost the battery cover, contact your OMRON retail outlet or distributor.

2.2 Pairing Your Monitor with a Smartphone

The date and time on your monitor will automatically be set when you pair your monitor with your smartphone.

Note

- You must download the app and pair it to your smartphone before you can use the ECG function.

Review the list of compatible smartphones at www.omronconnect.com/devices/. Any devices and operating systems not listed on our website are not supported.

1. **Enable Bluetooth on your smartphone.**
2. **Download and install the free “OMRON connect” app onto your smartphone.**



If you already have this app and have created your account, open the app and add your new monitor.

3. **Open the app and follow the pairing instructions shown on your smartphone.**

2. Preparation

4. Confirm that your monitor is connected successfully.

When your monitor is connected successfully to your smartphone, the “OK” symbol flashes.

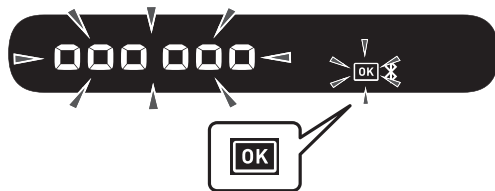

5. Press the BP [START/STOP] button to turn your monitor off.

Note

- Your monitor will automatically turn off after 10 seconds.
- Even if you do not pair this monitor to set the date and time, any blood pressure readings you take with this monitor will be transferred when pairing.
- If you have some pairing troubles, refer to section 11.
- Please be aware that OMRON will not be responsible for the loss of data and/or information in the app.
- “OMRON connect” is the only app that we recommend to use with your monitor to transfer your blood pressure readings and record and view your ECG results correctly.

2.3 Blood Pressure Measurement/ECG Recording Tips

Blood pressure measurement tips to help ensure an accurate reading:

- Stress raises blood pressure. Avoid taking measurements during stressful times.
- Measurements should be taken in a quiet place.
- It is important to take measurements at the same times each day. Taking measurements in the morning and in the evening is recommended.
- Remember to have a record of your blood pressure and pulse readings for your physician. A single measurement does not provide an accurate indication of your true blood pressure. Please use the included Blood Pressure Diary to keep records of several readings over a certain period of time. To download the PDF files of the Blood Pressure Diary or Blood Pressure Pass, visit www.omron-healthcare.com.

Caution

- Avoid bathing, drinking alcohol or caffeine, smoking, exercising and eating for at least 30 minutes before taking a blood pressure measurement.
- Rest for at least 5 minutes before taking a blood pressure measurement.

ECG recording tips to help ensure an accurate recording:

- Clean the 4 electrodes with alcohol-based sanitizer. Refer to sub-section 12.3.
- Disconnect headphones, charger cables, or any other connected devices from your smartphone.
- We recommend taking resting heart rate ECGs when you first rise in the morning; the time of day when the body is most rested.

3. Taking a Blood Pressure Measurement and Recording an ECG

There are 3 ways to use this monitor.

1. Taking a blood pressure measurement and recording an ECG simultaneously: refer to the steps in this section.
2. Taking only a blood pressure measurement: refer to section 4.
3. Recording only an ECG: refer to section 5.

3.1 Applying the Arm Cuff

Note

- The following steps are for applying the arm cuff to your left arm. When you take a measurement on your right arm, follow the cuff wrap instructions for a right arm use mentioned under “Note” located at the end of this sub-section.
- The blood pressure can differ between the right arm and the left arm, and the measured blood pressure readings can be different. OMRON recommends to always use the same arm for measurement. If the blood pressure readings between both arms differ substantially, check with your physician to determine as to which arm to use for your measurements.

Caution

- Remove tight-fitting and thick clothing from your arm while taking a measurement.

1. **Plug the arm cuff into your monitor by inserting the air plug into the air jack securely until it clicks.**

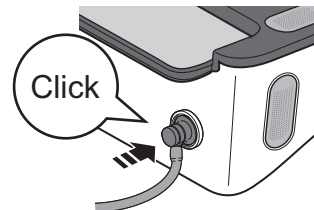

2. Place your hand through the cuff loop. Pull the cuff until it reaches your upper left arm.

Note

- The bottom edge of the arm cuff should be 1 to 2 cm above the inside elbow. The air tube is on the inside of your arm and aligned with your middle finger.

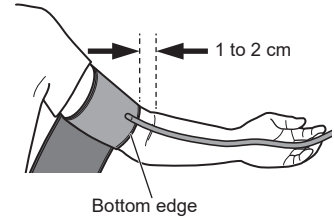

3. Make sure that the air tube is positioned on the inside of your arm and wrap the cuff securely so it can not move around your arm.

Note

- When you take a measurement on your right arm, the air tube should run along the side of your elbow, along the bottom of your arm. Be careful not to rest your arm on the air tube.



3. Taking a Blood Pressure Measurement and Recording an ECG

3.2 Sitting Correctly

To take a blood pressure measurement and record an ECG, you need to be relaxed and comfortably seated in a quiet room with a comfortable temperature.

- Sit in a comfortable chair with your back and arms supported.
- Keep your feet flat and your legs uncrossed.
- Both arms should be resting comfortably on a table.
- Place your monitor close enough to touch with your bent elbows.
- The arm cuff should be placed on your arm at the same level as your heart for a blood pressure measurement.

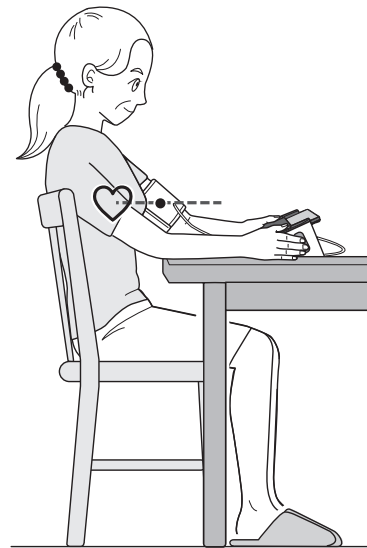

3.3 Taking a Blood Pressure Measurement and Recording an ECG

Note

- To stop a blood pressure measurement and an ECG recording, release both your hands from the electrodes and press the BP [START/STOP] button on the monitor to deflate the arm cuff.

Caution

- DO NOT use this monitor with other medical electrical (ME) equipment simultaneously. This may result in incorrect operation of the devices and/or cause inaccurate blood pressure readings and/or ECG recordings.
- Remain still and DO NOT talk while taking a blood pressure measurement.
- Remain still while recording an ECG.
- When your fingertips are dry, your ECG recording may not be successful. If dry, moisten your fingers with a wet towel, a water-based lotion, or something similar.
- DO NOT record an ECG with dirty hands.
- Make sure to place your smartphone on the smartphone stand of the monitor when recording an ECG. If it is not placed appropriately on the smartphone stand, it may lead to communication issues between the smartphone and the monitor, and your ECG may not be recorded successfully.

1. **Open the “OMRON connect” app on your smartphone.**
2. **Follow the instructions to start an ECG recording on your smartphone. Refer to the “Help” section on the app for more detail.**

3. Taking a Blood Pressure Measurement and Recording an ECG

- 3. Place your smartphone on the smartphone stand of your monitor.**



Note

- Make sure to sit correctly. Refer to sub-section 3.2.

- 4. Press the BP [START/STOP] button to take a blood pressure measurement.**

All symbols appear on the BP reading display of the monitor before starting.
The arm cuff will start inflating in few seconds.

5. Touch 4 electrodes as shown in the image.

Relax your hands. Put your thumbs on the top electrodes, and 2 or more fingers on each of the side electrodes to record your ECG.

Once fingers are placed on the electrodes, an ECG recording will automatically start.

Note

- To reduce muscle noise, rest your arms on a flat surface for better support while you are recording an ECG.
- To link both results (blood pressure readings and ECG recordings) mutually on the app, touch 4 electrodes as soon as pressing the BP [START/STOP] button.

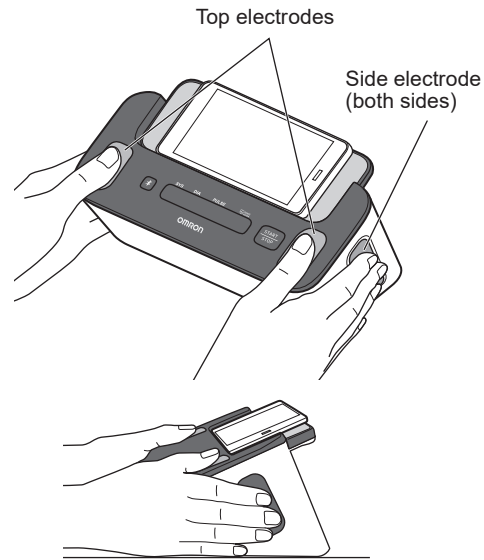



6. Remain still and do not talk until the entire measurement and recording process is complete.

3. Taking a Blood Pressure Measurement and Recording an ECG

Blood pressure measurement

- 1) The “” symbol flashes at every heartbeat.

Note

- The “” symbol appears if the arm cuff is wrapped around the arm correctly.
 - When the “” symbol is displayed, the arm cuff is not applied correctly. Press the BP [START/STOP] button to turn your monitor off, then apply the cuff correctly.
- 2) After your monitor has detected your blood pressure and pulse rate, the cuff automatically deflates. Your blood pressure and pulse rate are displayed on the monitor.
 - 3) As soon as a blood pressure measurement is complete, the blood pressure reading will be transferred to your smartphone.

Note

- On the paired smartphone, Bluetooth must be enabled.

BP reading display for blood pressure measurement

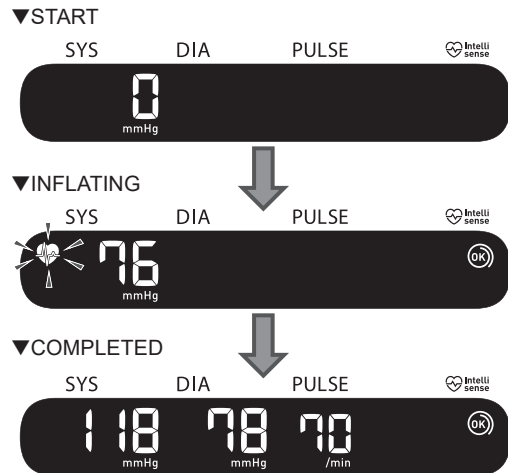

ECG recording

- 1) The app starts a 30-second countdown and shows the ECG wave on your smartphone.
- 2) After completion of an ECG recording, an ECG analysis result (Possible Afib, Bradycardia, Tachycardia, Normal, Unreadable, Unclassified or other messages) appears on your smartphone screen. Refer to sub-section 1.5 for details.
- 3) Blood pressure reading also appears on your smartphone screen. It may take some time.

Note

- The recording must be at least 30 seconds to complete, and to be analyzed by the detectors. You can change the recording duration if necessary. Refer to sub-section 10.2.



The illustration used is the image of the app. It is subject to change without notice.

3. Taking a Blood Pressure Measurement and Recording an ECG

7. Release both of your hands from the electrodes and remove the arm cuff.

Note

- After taking a blood pressure measurement and recording an ECG, you can promptly add tags such as symptoms, activities or personalized notes on the app.

8. Press the BP [START/STOP] button to turn your monitor off.

Note

- Your monitor will automatically turn off after 2 minutes.
- Wait 2-3 minutes between blood pressure measurements. The wait time allows the arteries to decompress and return to their pre-measurement state. You may need to increase the wait time depending on your individual physiological characteristics.
- Your monitor stores up to 90 blood pressure readings in the internal memory, but the previous readings cannot be viewed on the monitor.
- If your systolic blood pressure is more than 210 mmHg, take a blood pressure measurement manually. Refer to section 7.
- When Bluetooth is enabled, the blood pressure readings will be transferred to your smartphone within 1 hour after taking a blood pressure measurement. If you need to transfer the blood pressure readings manually, refer to section 6.

4. Taking Only a Blood Pressure Measurement

Note

- You can take a blood pressure measurement without pairing to a smartphone. To pair your monitor with your smartphone, refer to sub-section 2.2.
- When taking a blood pressure measurement and recording an ECG simultaneously, refer to section 3.
- When recording only an ECG, refer to section 5.

EN

Caution

- DO NOT use this monitor with other medical electrical (ME) equipment simultaneously. This may result in incorrect operation of the devices and/or cause inaccurate blood pressure readings and/or ECG recordings.
- Remain still and DO NOT talk while taking a blood pressure measurement.

1. Apply the arm cuff. Refer to sub-section 3.1.

2. Sit correctly. Refer to sub-section 3.2.

3. Press the BP [START/STOP] button to take a blood pressure measurement.

All symbols appear on the BP reading display of the monitor before starting. The arm cuff will start inflating in few seconds.

Note



- To stop a blood pressure measurement, press the BP [START/STOP] button once to deflate the arm cuff.

4. Taking Only a Blood Pressure Measurement

4. Remain still and do not talk until the entire measurement process is complete.

- 1) The “” symbol flashes at every heartbeat.

Note

- The “” symbol appears if the arm cuff is wrapped around the arm correctly.
- When the “” symbol is displayed, the arm cuff is not applied correctly. Press the BP [START/STOP] button to turn your monitor off, then apply the cuff correctly.

- 2) After your monitor has detected your blood pressure and pulse rate, the cuff automatically deflates. Your blood pressure and pulse rate are displayed on the monitor.

Note

- If your monitor has not been paired with your smartphone, skip following steps 3) and 4).

- 3) As soon as your measurement is complete, open the “OMRON connect” app on your smartphone to transfer your blood pressure readings.

Note

- On the paired smartphone, Bluetooth must be enabled.
- When Bluetooth is enabled, the blood pressure readings will be transferred to your smartphone within 1 hour after taking a blood pressure measurement. If you need to transfer the blood pressure readings manually, refer to section 6.

- 4) You can view your blood pressure readings on the app.

5. Remove the arm cuff.

6. Press the BP [START/STOP] button to turn your monitor off.

Note

- Your monitor will automatically turn off after 2 minutes.
- Wait 2-3 minutes between blood pressure measurements. The wait time allows the arteries to decompress and return to their premeasurement state. You may need to increase the wait time depending on your individual physiological characteristics.
- Your monitor stores up to 90 blood pressure readings in the internal memory, but the previous readings cannot be viewed on the monitor.
- If your systolic blood pressure is more than 210 mmHg, take a blood pressure measurement manually. Refer to section 7.

5. Recording Only an ECG

Note

- When taking a blood pressure measurement and recording an ECG simultaneously, refer to section 3.
- When taking only a blood pressure measurement, refer to section 4.



Caution

- Remain still while recording an ECG.
- When your fingertips are dry, your ECG recording may not be successful. If dry, moisten your fingers with a wet towel, a water-based lotion, or something similar.
- DO NOT record an ECG with dirty hands.
- Make sure to place your smartphone on the smartphone stand of the monitor when recording an ECG. If it is not placed appropriately on the smartphone stand, it may lead to communication issues between the smartphone and the monitor, and your ECG may not be recorded successfully.

1. **Sit correctly. Refer to sub-section 3.2.**
2. **Open the “OMRON connect” app on your smartphone.**
3. **Follow the instructions to start an ECG recording on your smartphone. Refer to the “Help” section on the app for more detail.**

4. Place your smartphone on the smartphone stand of your monitor.

5. Touch 4 electrodes as shown in the image.

Relax your hands. Put your thumbs on the top electrodes, and 2 or more fingers on each of the side electrodes to record your ECG.

Once fingers are placed on the electrodes, an ECG recording will automatically start.

Note

- To reduce muscle noise, rest your arms on a flat surface for better support while you are recording an ECG.

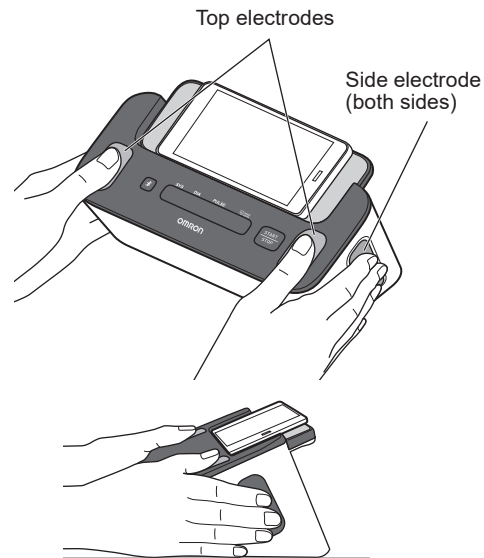

5. Recording Only an ECG

6. Remain still until the entire recording process is complete.

- 1) The app starts a 30-second countdown and shows the ECG wave on your smartphone.
- 2) After completion of an ECG recording, an ECG analysis result (Possible Afib, Bradycardia, Tachycardia, Normal, Unreadable, Unclassified or other messages) will appear on your smartphone. Refer to sub-section 1.5 for details.

Note

- The recording must be at least 30 seconds to complete, and to be analyzed by the detectors. You can change the recording duration if necessary. Refer to sub-section 10.2.

7. Release both of your hands from the electrodes.

Note

- If you accidentally pressed the BP [START/STOP] button, press the button again to stop the blood pressure measurement process.
- After recording an ECG, you can promptly add tags such as symptoms, activities or personalized notes on the app.

6. Transferring Your Blood Pressure Readings Manually

As soon as a blood pressure measurement is complete, open the “OMRON connect” app on your smartphone to transfer your blood pressure readings. If you need to transfer the blood pressure readings later, try transferring them manually.

1. Make sure your monitor is within 5 m of your smartphone.

2. Open the “OMRON connect” app on your smartphone.

Note



- Make sure that your monitor is turned off. If it is on, press the BP [START/STOP] button to clear the LCD screen.
-

3. Press the button on the monitor to transfer your blood pressure readings.

If your blood pressure readings are successfully transferred to the app, “OK” will flash on the BP reading display of the monitor.

4. Press the BP [START/STOP] button to turn your monitor off.

Note

- Your monitor will automatically turn off after 10 seconds.
- This monitor will store up to 90 blood pressure readings. Stored blood pressure readings cannot be viewed on the BP reading display of the monitor. You can view your blood pressure readings on the app after transferring. When the “” symbol appears on the BP reading display, the stored memory on the monitor is almost full. Transfer the blood pressure readings immediately before your readings are deleted.
- When the “” symbol appears on the BP reading display of the monitor, enable Bluetooth of your monitor. Refer to sub-section 8.1.
- Once you send your blood pressure readings to the app, the readings cannot be sent again to the app or smartphone.

7. Taking a Blood Pressure Measurement Manually

If your systolic blood pressure is more than 210 mmHg, take a blood pressure measurement manually.

Prepare for taking a blood pressure measurement by referring to sub-sections 3.1 and 3.2.

And press the BP [START/STOP] button.

After the arm cuff starts to inflate, press and hold the BP [START/STOP] button until the monitor inflates 30 to 40 mmHg higher than your expected systolic blood pressure.

Note

- Do not inflate above 299 mmHg.
- You can not record an ECG simultaneously when taking a blood pressure measurement manually.

Caution

- Inflating to a higher pressure than necessary may result in bruising of the arm where the cuff is applied.

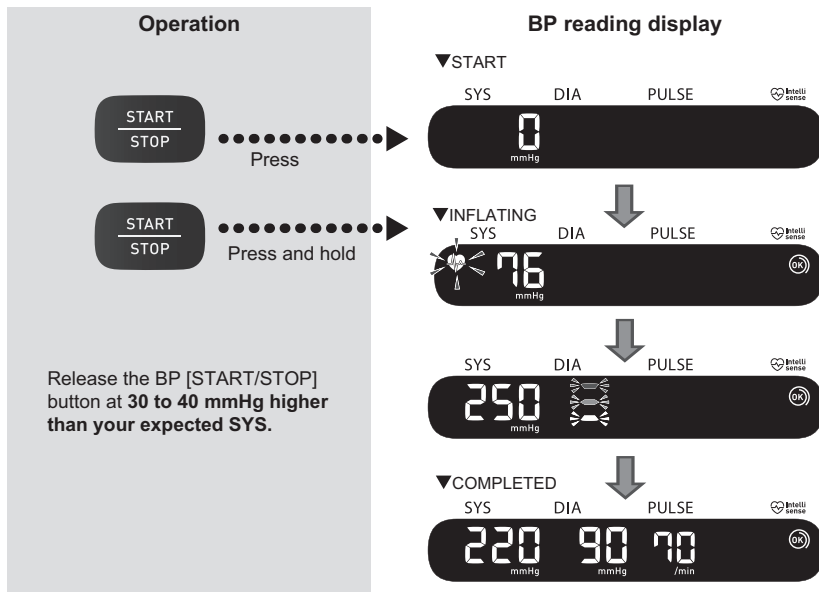

8. Other Settings of the Monitor

8.1 Disabling/Enabling Bluetooth

Disable Bluetooth in your monitor in the following areas where use of wireless equipment is prohibited.

- On aircraft
- In hospitals
- While abroad

Bluetooth is enabled as default.

EN



1. **When your monitor is off, press and hold the  button on the monitor for more than 10 seconds.**

“oFF” appears on the BP reading display.



2. **Press the BP [START/STOP] button to turn your monitor off.**

Note

- When Bluetooth is disabled and the BP reading display is active, the  symbol appears.
- To enable Bluetooth, press and hold the  button for more than 2 seconds. “on” appears on the BP reading display.
- Your monitor will automatically turn off within 2 minutes after completion.

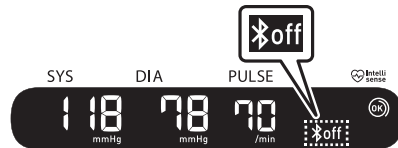

8. Other Settings of the Monitor

8.2 Restoring Your Monitor to the Default Settings

To delete all the information stored in your monitor, follow the instructions below. Make sure that your monitor is turned off.

1. While holding the  button down, press and hold the BP [START/STOP] button for more than 10 seconds.



2. Release the  button and BP [START/STOP] button when “CLr” appears on the BP reading display.

Your monitor reverts back to the default settings.



3. Press the BP [START/STOP] button to turn your monitor off.

Note

- Reverting to the default settings of your monitor does not delete the information in the app.
- Your monitor will automatically turn off after 2 minutes.
- You will need to re-pair your monitor when using the monitor again. Without re-pairing, your blood pressure readings will not be transferred to your app.

9. Tracking Your Memory in the App

For tracking your memories, open the “OMRON connect” app and follow the instructions.

9.1 Tracking Your ECG Recordings

1. Tap the “Electrocardiogram” section on the Home screen to see a list of all ECG recordings on your smartphone (excluding any previously deleted).
2. Tap the ECG recording you wish to view.

Note

- The “OMRON connect” app has the function of emailing, printing and deleting ECG recordings. When you use these functions, refer to the guidance on the app.

9.2 Tracking Your Blood Pressure Readings

1. Tap the “Blood Pressure” section on the Home screen to see all blood pressure readings on your smartphone (excluding any previously deleted).

Note

- Stored blood pressure readings cannot be viewed on the BP reading display of the monitor. You can view your blood pressure readings on the app after transferring.

10. ECG Settings and Adjustments in the App

For settings and adjustments, open the “OMRON connect” app and follow the instructions.

10.1 Recording Review Adjustments

Enhanced Filter

The Enhanced filter suppresses noise in the ECG. From the ECG review screen, tap the graph, then change the filter setting.

Invert the ECG Recording

The orientation can be toggled on a particular ECG. From the ECG review screen, tap the graph, then invert the graph.

10.2 Adjustable Settings

To access the settings, tap “Devices” from the app menu. Select your device, and change your settings.

Duration

Recording duration is the maximum length of time of a single ECG recording. For example, if the recording duration is set to 30 seconds, the app will automatically stop recording after 30 seconds of data collection. The duration is set to 30 seconds as default.

Mains Filter

The Mains filter removes any mains interference from the ECG; it should be set to match the frequency of the alternating current (AC) used in your location, either 50 Hz or 60 Hz.

11. Error Messages and Troubleshooting



If any of the below problems occur during a blood pressure measurement and an ECG recording, check to make sure that the monitor is 30 cm from other electrical devices, except for the smartphone that is being used with the monitor. For example, electrical outlets, PCs, PC monitors or other wireless devices such as Wi-Fi routers which emit radio frequencies. If the problem persists, refer to the table below.





EN

Monitor and blood pressure measurements





BP reading display / Problem	Possible Cause	Solution
 appears or the arm cuff does not inflate.	The BP [START/STOP] button was pressed while the arm cuff is not applied.	Press the BP [START/STOP] button again to turn the monitor off. After inserting the air plug securely and applying the arm cuff correctly, press the BP [START/STOP] button.
	Air plug is not completely plugged into the monitor.	Insert the air plug securely. Refer to sub-section 3.1.
	The arm cuff is not applied correctly.	Apply the arm cuff correctly, then take another measurement. Refer to sub-section 3.1.
	Air is leaking from the arm cuff.	Replace the arm cuff with a new one. Contact your OMRON retail outlet or distributor.



11. Error Messages and Troubleshooting

BP reading display / Problem	Possible Cause	Solution
 appears or a measurement cannot be complete after the arm cuff inflates.	You move or talk during a measurement and the arm cuff does not inflate sufficiently.	Remain still and do not talk during a blood pressure measurement. If “E2” appears repeatedly, inflate the arm cuff manually until the systolic pressure is 30 to 40 mmHg above your previous blood pressure readings. Refer to section 7.
	Due to the systolic pressure is above 210 mmHg, a measurement cannot be taken.	
 appears	The arm cuff is inflated exceeding the maximum allowable pressure.	Do not touch the arm cuff and/or bend the air tube while taking a measurement. If inflating the arm cuff manually, refer to section 7.
 appears	You move or talk during a measurement. Vibrations disrupt a measurement.	Remain still and do not talk during a measurement.

BP reading display / Problem	Possible Cause	Solution
 appears	<p>The pulse rate is not detected correctly.</p>	<p>Apply the arm cuff correctly, then take another measurement. Refer to sub-section 3.1. Remain still and sit correctly during a measurement.</p>
 appears		
 appears		
 does not flash during a measurement.		
 appears	<p>The monitor has malfunctioned.</p>	<p>Press the BP [START/STOP] button again. If "Er" still appears, contact your OMRON retail outlet or distributor.</p>

11. Error Messages and Troubleshooting

BP reading display / Problem	Possible Cause	Solution
 appears	The monitor cannot connect to a smartphone or transmit blood pressure readings correctly.	Follow the instructions shown in the “OMRON connect” app. If the “Err” symbol still appears after checking the app, contact your OMRON retail outlet or distributor.
 flashes	The monitor is waiting for pairing with the smartphone.	Refer to sub-section 2.2 for pairing your monitor with your smartphone or press the BP [START/STOP] button to cancel pairing and turn your monitor off.
 flashes	The monitor is ready to transfer blood pressure readings to the smartphone.	Open the “OMRON connect” app to transfer your blood pressure readings.
 flashes	Internal stored blood pressure memory is almost full.	Pair or transfer your blood pressure readings to the “OMRON connect” app so you can keep them in memory in the app, and this error symbol disappears.
 appears	Internal stored blood pressure memory is completely full.	

BP reading display / Problem	Possible Cause	Solution
 appears	Batteries are low.	Replacing all 4 batteries with new ones is recommended. Refer to sub-section 2.1.
 appears or the monitor is turned off unexpectedly during a measurement.	Batteries are depleted.	Immediately replace all 4 batteries with new ones. Refer to sub-section 2.1.
Nothing appears on the BP reading display of the monitor.	Battery polarities are not properly aligned.	Check the battery installation for proper placement. Refer to sub-section 2.1.
Blood pressure readings appear too high or too low.	Blood pressure varies constantly. Many factors including stress, time of day, and/or how you apply the arm cuff, may affect your blood pressure. Review sub-sections 2.3, 3.1 and 3.2.	
Any other problems occur.	Press the BP [START/STOP] button to turn the monitor off, then press it again to take a blood pressure measurement. If the problem continues, remove all batteries and wait for 30 seconds. Then, reinstall batteries. If the problem still persists, contact your OMRON retail outlet or distributor.	

11. Error Messages and Troubleshooting

ECG recordings

Problem	Solution
I have a lot of artifact, noise, interference, or cannot see ECG in my ECG recording.	<p>Ensure that the “OMRON connect” app has access to the microphone of the smartphone. Open the settings of your smartphone, and enable the microphone of the app.</p> <p>Try the following tips for acquiring the best quality ECG recording:</p> <ul style="list-style-type: none">• Clean the electrodes of the monitor with an alcohol-based sanitizer.• If hands are very dry, use a water-based lotion before recording.• Relax both arms and hands to reduce muscle noise. Both arms should be resting comfortably on a table.• Ensure that your smartphone is not charging/syncing and you are not using headphones or any other connected devices with your smartphone during the ECG recording.• Make sure that both the smartphone and the user remain still during ECG recordings. Movement during recordings will cause noise in the tracing.
The HUD symbol is covered up when I rotate my smartphone	<p>The heads up display (HUD) symbol can sometimes be partially obstructed when you rotate your smartphone while it’s busy. This isn’t a concern; the HUD symbol is just letting you know that the app is working. This doesn’t impact your ECG recording or any of your information.</p>
I see large spikes at the start of my ECG recording	<p>Large amounts of noise/artifact can be seen for the first few milliseconds of an ECG recording when the enhanced filter is looking for your heartbeat. This is very rare and only lasts until your first heartbeat is seen in the app; this doesn’t affect the rest of your ECG recording.</p>
Any other communication issue occurs.	<p>Follow the instructions shown in the smartphone, or visit the “Help” section in the “OMRON connect” app for further help.</p> <p>If the problem still persists, contact your OMRON retail outlet or distributor.</p>

12. Maintenance

12.1 Maintenance

To protect your monitor from damage, follow the directions below:

- Changes or modifications not approved by the manufacturer will void the user warranty.

Caution

- DO NOT disassemble or attempt to repair this monitor or other components. This may cause an inaccurate blood pressure readings and/or ECG recordings.

12.2 Storage

Keep your monitor and other components in the storage case when not in use.

- Store your monitor and other components in a clean, safe location.

1. Remove the arm cuff from the monitor.

The air plug is firmly connected not to come off accidentally.

When removing the arm cuff from the monitor, pull the air plug in a straight way from the air jack. It clicks during pulling out.

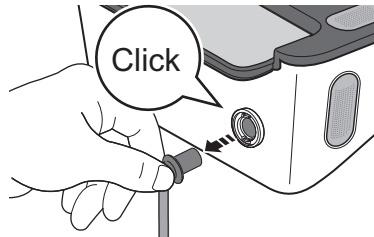

12. Maintenance

2. Gently fold the air tube into the arm cuff.

Note

- Do not bend or crease the air tube excessively.

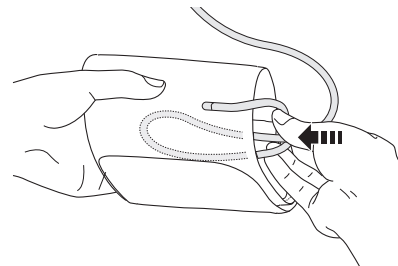

Caution

- To unplug the air plug, pull on the plastic air plug at the base of the tube, not the tube itself.

3. Place your monitor with both hands and other components into the storage case.

Do not store your monitor and other components:

- If the monitor and other components are wet.
- In locations exposed to extreme temperatures, humidity, direct sunlight, dust or corrosive vapors such as bleach.
- In locations exposed to vibrations or shocks.

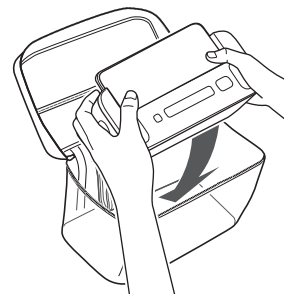

12.3 Cleaning

- Do not use any abrasive or volatile cleaners.
- Use a soft dry cloth or a soft cloth moistened with mild (neutral) detergent to clean your monitor and the arm cuff and then wipe them with a dry cloth.
- When electrodes are dirty, use a soft cloth or cotton swab moistened with alcohol-based sanitizer to clean the electrodes.
- Do not use alcohol to clean any other parts, and use it only to clean electrodes.
- Do not wash or immerse your monitor and arm cuff or other components in water.
- Do not use gasoline, thinners or similar solvents to clean your monitor and arm cuff or other components.

12.4 Calibration and Service

- The accuracy of this blood pressure monitor has been carefully tested and is designed for a long service life.
- It is generally recommended to have the unit inspected every two years to ensure correct functioning and accuracy. Please consult your authorised OMRON dealer or the OMRON Customer Service at the address given on the packaging or attached literature.

13. Optional Accessories

Arm cuff

Arm circumference
17 - 22 cm

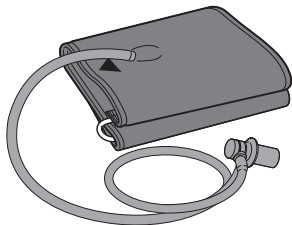

Model: HEM-CS24

Arm circumference
22 - 42 cm

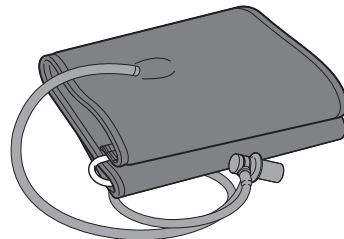

Model: HEM-RML31

- Same as the arm cuff provided with the product.

Note

- Do not throw the air plug away. The air plug can be applicable to the optional cuff.

14. Specifications

Product category	Electronic Sphygmomanometers with Electrocardiograph function
Product description	Automatic Upper Arm Blood Pressure Monitor Single lead electrocardiogram
Model (code)	Complete (HEM-7530T-E3)
BP reading display	LCD digital display
Operation mode	Continuous operation
IP classification	IP 21
Rating	DC6 V 4 W
Power source	4 "AA" alkaline batteries 1.5 V
Battery life	Approximately 300 measurements (using new alkaline batteries)
Durable period (Service life)	Monitor: 5 years Cuff: 5 years
Operating conditions	+10 °C to +40 °C / 15 to 90 % RH (non-condensing) / 800 to 1060 hPa
Storage / Transport conditions	-20 °C to +60 °C / 10 to 90 % RH (non-condensing)
Weight	Monitor: Approximately 550 g not including batteries Arm cuff: Approximately 170 g
Dimensions	Monitor: Approximately 232 mm (w) × 98 mm (h) × 123 mm (l) Arm cuff: Approximately 145 mm × 594 mm (air tube: 750 mm)
Applied part	Type BF (arm cuff), Type CF (electrodes)
Protection against electric shock	Internally powered ME equipment
Maximum temperature of the applied part	Lower than +48 °C
Contents	Monitor, arm cuff (HEM-RML31), storage case, 4 "AA" alkaline batteries, instruction manual, setup instructions, blood pressure diary

14. Specifications

Blood pressure measurement

Cuff pressure range

0 to 299 mmHg

Blood pressure measurement range

SYS: 60 to 260 mmHg

DIA: 40 to 215 mmHg

Pulse measurement range

40 to 180 beats / min.

Accuracy

Pressure: ± 3 mmHg

Pulse: ± 5 % of display reading

Inflation

Automatic by electric pump

Deflation

Automatic pressure release valve

Measurement method

Oscillometric method

Transmission method

Bluetooth[®] Low Energy

Wireless communication

Frequency range: 2.4 GHz (2400 - 2483.5 MHz)

Modulation: GFSK

Effective radiated power: <20 dBm

Cuff circumference applicable to the monitor

17 to 42 cm (included arm cuff: 22 to 42 cm)

Internal Memory

Stores up to 90 blood pressure readings

ECG recording

Performance characteristics

ECG channel: Single channel

Input dynamic range: 10 mV Peak-to-Peak

Frequency response: 0.67 Hz to 40 Hz

CMRR: > 60 dB

Input Impedance: > 10 M Ω

Output

Modulation: Frequency modulated ultrasonic audio tone

Center frequency: 19 kHz

Modulation index: 200 Hz/mV

Accuracy of Afib algorithm98% sensitivity and 97% specificity¹

1. Lau JK, Lowres N, Neubeck L, Brieger DB, Sy RW, Galloway CD, et al. Int J Cardiol. 2013;165(1):193-4

Note

- These specifications are subject to change without notice.
- This monitor complies with the requirements of EN ISO 81060-2:2014 and complies with EN ISO 81060-2:2014 and EN ISO 81060-2:2019 + A1:2020 (excluding pregnant and pre-eclampsia patients). In the clinical validation study, K5 was used on 85 subjects for determination of diastolic blood pressure.
- IP classification is degrees of protection provided by enclosures in accordance with IEC 60529. This monitor is protected against solid foreign objects of 12.5 mm diameter and greater such as a finger, and against vertically falling water drops which may cause issues during a normal operation.
- Operation mode is classification in accordance with IEC 60601-1.
- The heart rate displayed during ECG acquisition is an average over the last 5 seconds.
- The heart rate displayed in review and on reports is the average heart rate over the entire ECG recording.
- The heart rate during recording an ECG has a range from 30 bpm to 300 bpm, and a resolution of 1 bpm.

About a wireless communication interference

The Bluetooth option in the product is used to connect to dedicated apps on mobile devices to synchronize date/time data from mobile device to the product, and to synchronize measurement data from the product to mobile device. Further handling of the data on the mobile device is up to the user's discretion. This product operates in an unlicensed ISM band at 2.4 GHz where any third party can intercept the radio waves, willfully or accidentally, for any unknown purpose. In the event this product is used near other wireless devices such as microwave and wireless LAN, which operate on the same frequency band as this product, there is a possibility that interference may occur. If interference occurs, stop the operation of the other devices or relocate this product away from other wireless devices before attempting to use it.

15. Limited Warranty

Thank you for buying an OMRON product. This product is constructed of high quality materials and great care has been taken in its manufacturing.

It is designed to give you a high level of comfort, provided that it is properly operated and maintained as described in the instruction manual. This product is warranted by OMRON for a period of 5 years after the date of purchase. The proper construction, workmanship and materials of this product is warranted by OMRON. During this period of warranty OMRON will, without charge for labour or parts, repair or replace the defect product or any defective parts.

The warranty does not cover any of the following:

- A. Transport costs and risks of transport.
- B. Costs for repairs and / or defects resulting from repairs done by unauthorised persons.
- C. Periodic check-ups and maintenance.
- D. Failure or wear of optional parts or other attachments other than the main device itself, unless explicitly warranted above.
- E. Costs arising due to non-acceptance of a claim (those will be charged for).
- F. Damages of any kind including personal caused accidentally or from misuse.
- G. Calibration service is not included within the warranty.
- H. Optional parts have a one (1) year warranty from date of purchase. Optional parts include, but are not limited to the following items: cuff and cuff tube.

Should warranty service be required please apply to the dealer whom the product was purchased from or an authorised OMRON distributor. For the address refer to the product packaging / literature or to your specialised retailer. If you have difficulties in finding OMRON customer services, visit our website (www.omron-healthcare.com) for contact information.









Repair or replacement under the warranty does not give rise to any extension or renewal of the warranty period.

The warranty will be granted only if the complete product is returned together with the original invoice / cash ticket issued to the consumer by the retailer.

16. Guidance and Manufacturer's Declaration











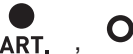

- This blood pressure monitor is designed according to the European Standard EN1060, Non-invasive sphygmomanometers Part 1: General Requirements and Part 3: Supplementary requirements for electromechanical blood pressure measuring systems.
- Hereby, OMRON HEALTHCARE Co., Ltd., declares that the radio equipment type HEM-7530T-E3 is in compliance with Directive 2014/53/EU. The full text of the EU declaration of conformity is available at the following internet address: www.omron-healthcare.com
- This OMRON product is produced under the strict quality system of OMRON HEALTHCARE Co., Ltd., Japan.
- Please report to the manufacturer and the competent authority of the Member State in which you are established about any serious incident that has occurred in relation to this device.

EN

Symbols description			
	Applied part - Type BF, Type CF Degree of protection against electric shock (leakage current)		LOT number
IP XX	Ingress protection degree provided by IEC 60529		Unique device identifier
	CE Marking		Medical Device
	UKCA marking		Humidity limitation
	Temperature limitation		Atmospheric pressure limitation

EN59

16. Guidance and Manufacturer's Declaration

Symbols description			
	OMRON's trademarked technology for blood pressure measurement	QUALITY PASS , 	Manufacturer's quality control mark
	Identifier of cuffs compatible for the device	LATEX FREE	Not made with natural rubber latex
	Cuff positioning indicator for the left arm		Arm circumference
	Marker on the cuff to be positioned above the artery		Need for the user to consult this instruction manual.
	Range pointer and brachial artery alignment position		Need for the user to follow this instruction manual thoroughly for your safety.
	Direct current		To indicate generally elevated, potentially hazardous, levels of non-ionizing radiation, or to indicate equipment or systems e.g. in the medical electrical area that include RF transmitters or that intentionally apply RF electromagnetic energy for diagnosis or treatment.
	Battery		
	Range indicator of arm circumferences to help selection of the correct cuff size		Date of manufacture

Important information regarding Electromagnetic Compatibility (EMC)

HEM-7530T-E3 conforms to EN60601-1-2:2015 Electromagnetic Compatibility (EMC) standard.
Further documentation in accordance with this EMC standard is available at www.omron-healthcare.com. Refer to the EMC information for HEM-7530T-E3 on the website.

16. Guidance and Manufacturer's Declaration

Correct Disposal of This Product (Waste Electrical & Electronic Equipment)

This marking shown on the product or its literature, indicates that it should not be disposed of, with other household wastes at the end of its working life.

To prevent possible harm to the environment or human health from uncontrolled waste disposal, please separate this product from other types of wastes and recycle it responsibly to promote the sustainable reuse of material resources.

Household users should contact either the retailer where they purchased this product, or their local government office, for details of where and how they can return this item for environmentally safe recycling.

Business users should contact their supplier and check the terms and conditions of the purchase contract. This product should not be mixed with other commercial waste for disposal.



The **Bluetooth**[®] word mark and logos are registered trademarks owned by Bluetooth SIG, Inc. and any use of such marks by OMRON HEALTHCARE Co., Ltd. is under license.

Apple and the Apple logo are trademarks of Apple Inc., registered in the U.S. and other countries and regions. App Store is a service mark of Apple Inc.



Google Play and the Google Play logo are trademarks of Google LLC.

The AliveCor[®] word mark and logo are owned by AliveCor, Inc. and are used with permission.

United States patents and patents pending: 8,509,882; 9,649,042; 8,301,232; 2017/0215755; 9,247,911; 9,681,814; 2017/0215756.

Other trademarks and trade names are those of their respective owners.

<https://www.omron-healthcare.com/>

	Manufacturer	Fabricant	Hersteller	OMRON HEALTHCARE Co., Ltd. 53, Kunotsubo, Terado-cho, Muko, KYOTO, 617-0002 JAPAN
	EU-representative	Mandataire dans l'UE	EU-Repräsentant	OMRON HEALTHCARE EUROPE B.V. Scorpius 33, 2132 LR Hoofddorp, THE NETHERLANDS www.omron-healthcare.com
	Importer in EU	Importateur dans l'UE	Importeur in der EU	
	Production Facility	Site de production	Produktionsstätte	OMRON HEALTHCARE Co., Ltd. Matsusaka Factory 1855-370, Kubo-cho, Matsusaka-shi, Mie, 515-8503 Japan
	Subsidiary	Succursale	Niederlassung	OMRON HEALTHCARE UK LTD. Opal Drive, Fox Milne, Milton Keynes, MK15 0DG, UK www.omron-healthcare.com/distributors
	Importer in the United Kingdom and UK responsible person	Importateur au Royaume-Uni et la personne responsable au Royaume-Uni	Importeur im Vereinigten Königreich und Verantwortliche Person für UK	
	Subsidiaries	Succursales	Niederlassungen	OMRON MEDIZINTECHNIK HANDELSGESELLSCHAFT mbH OMRON SANTÉ FRANCE SAS www.omron-healthcare.com/distributors

Made in Japan / Fabriqué au Japon / Hergestellt in Japan

Issue Date / Date de publication / Ausgabedatum : 2022-07-01
IM1-HEM-7530T-E3-03-01/2022
5648435-8D